

airCore 700

—
Single split system
for light commercial and homes
Heat pump

Cooling & Heating



air

—
Johnson Controls - Hitachi Air Conditioning

ADDRESS
New Pier Takeshiba South Tower
1-16-1, Kaigan Minato-ku, Tokyo 105-0022, JAPAN
Tel: +81-3-6721-5567
<https://www.hitachiaircon.com>

HITACHI. CERTIFIED QUALITY

The specifications of this catalog may change without prior notice to allow Hitachi Cooling & Heating to incorporate the latest innovations for its customers. The information contained in this catalog is merely informative. Hitachi Cooling & Heating declines any responsibility in the broadest sense, for damage, direct or indirect, arising from the use and / or interpretation of the recommendations in this catalog.

Find the products Hitachi Cooling & Heating with the best service and conditions at your Hitachi Distributor.

airCore700-C-2501

Hitachi provides a comprehensive range of split air conditioning systems designed for various applications, catering to both small commercial projects and residential settings.

The new light commercial split system, **airCore 700**, incorporates features that offer superior comfort, achieve outstanding energy efficiency, simplify installation, and streamline maintenance. This ensures a superior living experience for users and provides convenience for professionals. Building owners and tenants will appreciate the diverse range of indoor unit design options that seamlessly blend into any interior space.



HOME



RESTAURANT



RETAIL



SUPERMARKET



CLASSROOM



OFFICE



Index

Key Messages

- 03 | Cooler, Greener, Smarter
- 05 | Key Applications
- 06 | Key Customers

Product Lineups

Outdoor Units

- 13 | Product features (Standard series)
- 19 | Product features (HeatForce series)

Indoor Units

- 25 | Ducted
- 27 | Cassette
- 37 | Ceiling suspended
- 39 | Air handling unit
- 40 | Highwall

Controllers

- 42 | Individual controllers
- 43 | Central Stations
- 48 | Apps
- 52 | H-LINK

Specifications

Key Messages



Cooler

Experience a world of limitless comfort.

We craft high-quality products with reliable performance, elevating comfort while seamlessly blending into the interior design.



Greener

Dedicated to protecting our planet without compromising on comfort and the living experience.

We continuously develop our products to enhance efficiency and save energy and reduce impact on the natural environment.

We prioritize low noise and quiet operation, ensuring a peaceful and serene lifestyle.



Smarter

Step into the era of intelligence, digitalization, and smart living.

Intelligent features make operation simple and effortless for occupants, maximizing automation while still allowing occupants to easily over-ride operation when they want to.

Rediscover the harmony of life.



Key Messages

Key Applications

airCore 700 is Hitachi's flagship light commercial split system. Our range of products for small businesses and homes enable HVAC professionals to work with a single reliable brand across a range of projects, benefiting from thoughtful design features that make installation easier and maintenance tasks lighter.

Meanwhile, building owners and tenants will appreciate the range of indoor unit design options that can seamlessly blend into any interior space.

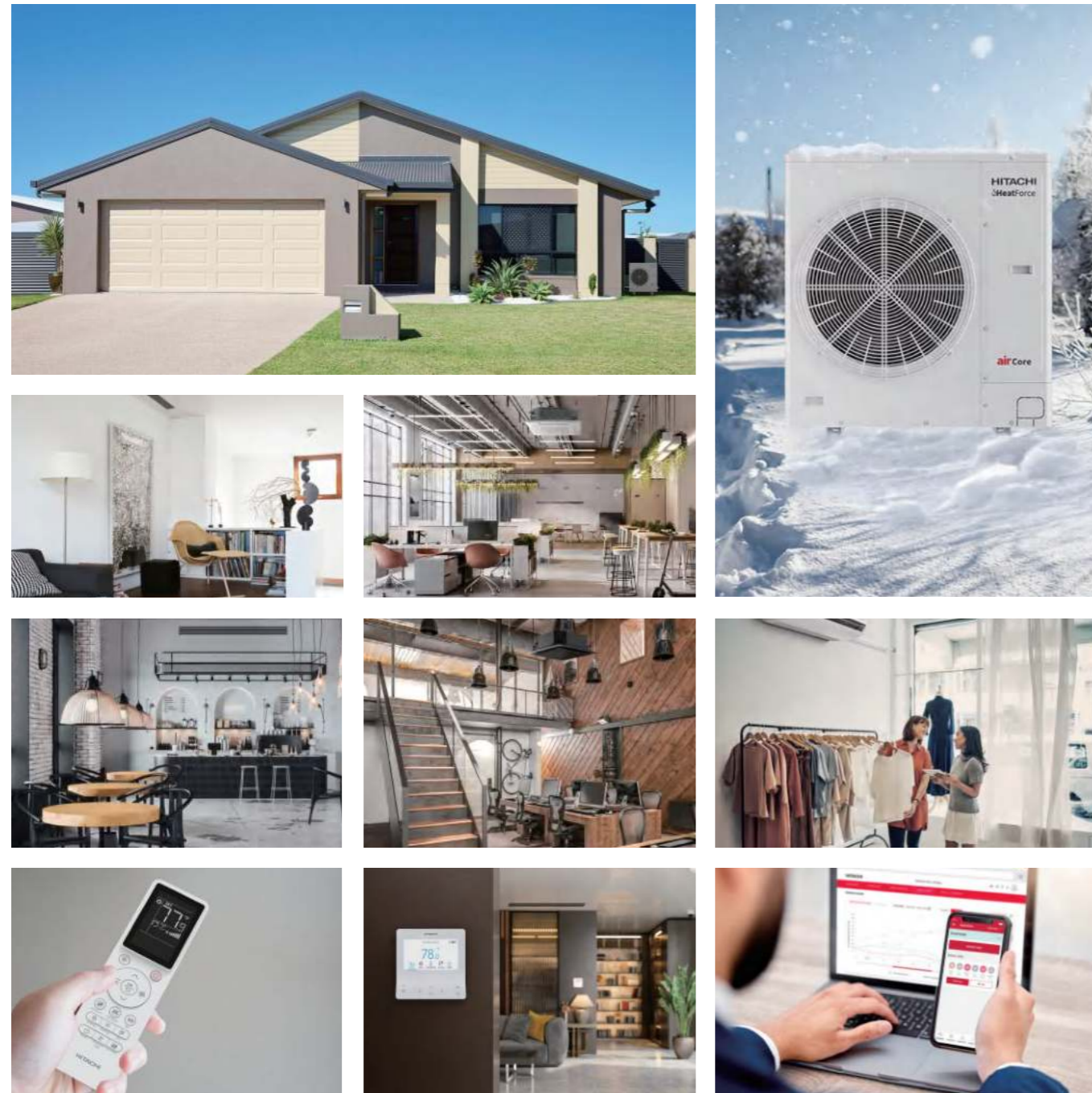

Key Customers

Hitachi's single-split system is ideal for budget-sensitive customers with smaller premises or homeowners who require larger cooling capacity. The AC system requires a lower investment, comprising multiple indoor unit types that can meet various needs. The diverse range of indoor unit options seamlessly blends into any interior space, satisfying architects, building owners, and tenants alike. Specific product features and user-friendly designs can make installation and maintenance much easier.



End Users



- Business Owners
- Homeowners
- Facility Managers

Building owners and tenants will appreciate the range of indoor unit design options that can seamlessly blend into any interior space.

For multi-zone or multi-room commercial spaces, our ducted solution reduces capital costs compared with a VRF solution, while still offering differentiated temperature control across several zones.

HVAC Professionals



- Interior designer
- HVAC system engineers
- Installers
- Maintenance and Service Engineers

Hitachi's range of light commercial split systems enable HVAC professionals to work with a single reliable brand for a wide range of small commercial projects, benefiting from thoughtful design features that make installation easier and maintenance tasks lighter.

Business Partners



- Distributors
- Contractors
- Sub-contractors

Hitachi supports our business partners by providing professional training and technical assistance. These resources help partners gain a comprehensive understanding of Hitachi's products and solutions, as well as the market landscape and customer needs. Ultimately, this collaborative approach aims to achieve mutually beneficial business goals and foster a win-win relationship.

Product Lineups

Capacity		9K	12K	18K	24K	30K	36K	48K
Outdoor Units (Standard)		 PAS-09BUFASDQ1	 PAS-12BUFASDQ1	 PAS-18BUFASDQ1	 PAS-24BUFASDQ1	 PAS-30BUFASDQ1	 PAS-36BUFASDQ1	 PAS-48BUFASDQ1
	Outdoor Units (HeatForce series)		 PAS-12BLFASDQ1	 PAS-18BLFASDQ1	 PAS-24BLFASDQ1	 PAS-30BLFASDQ1	 PAS-36BLFASDQ1	
Indoor Units	Ducted MSP	 PPIM-B09UFA1DQ	 PPIM-B12UFA1DQ	 PPIM-B18UFA1DQ	 PPIM-B24UFA1DQ	 PPIM-B30UFA1DQ	 PPIM-B36UFA1DQ	 PPIM-B48UFA1DQ
	4-way Cassette	 PCIM-B09UFA1DQ	 PCIM-B12UFA1DQ	 PCI-B18UFA1DQ	 PCI-B24UFA1DQ	 PCI-B30UFA1DQ	 PCI-B36UFA1DQ	 PCI-B48UFA1DQ
	Cassette Human Sensor Panel (optional)	 P-AP160NAE1	 P-AP160NAE1	 P-AP160NAE1	 P-AP160NAE1	 P-AP160NAE1	 P-AP160NAE1	 P-AP160NAE1
	Silent Iconic (optional)	 P-GP160NAP*US	 P-GP160NAP*US	 P-GP160NAP*US	 P-GP160NAP*US	 P-GP160NAP*US	 P-GP160NAP*US	 P-GP160NAP*US
	Ceiling Suspended (Unavailable for HeatForce series)	 PPFC-B09UFA1DQ	 PPFC-B12UFA1DQ	 PPFC-B18UFA1DQ	 PPFC-B24UFA1DQ	 PPFC-B30UFA1DQ	 PPFC-B36UFA1DQ	 PPFC-B48UFA1DQ
Air Handling Unit			 JPE18B3XB2HS1A	 JPE24B3XC2HS1A	 JPE30B3XD2HS1A	 JPE36B3XD2HS1A	 JPE48C3XG2HS1A	
Highwall	 PPK-B09UFA1DQ	 PPK-B12UFA1DQ	 PPK-B18UFA1DQ	 PPK-B24UFA1DQ	 PPK-B30UFA1DQ			

PRODUCT LINEUP

Outdoor units

- 10 | Lineup
- 11 | A glance at new technologies and features
- 13 | Product features (Standard series)
- 19 | Product features (HeatForce series)

Standard series

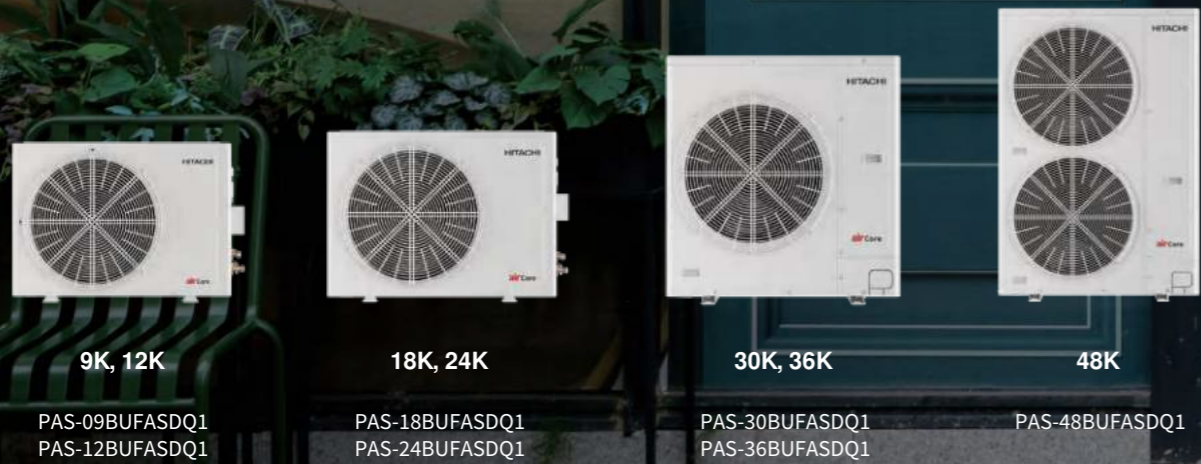

HeatForce series



Outdoor units

A GLANCE AT NEW TECHNOLOGIES AND FEATURES

Fan design

- Adopt DC motor with 16 speed control, more energy saving and higher energy efficiency.

Superior compressor and pre-heating Function

- Adopt new R32 DC inverter compressors that incorporates Hitachi's exclusive compressor control technology.
- Uses advanced multi-pulse control induction on coil, core, rotor and stator, eliminating use of external crankcase heater
- Enhances efficiency of pre-heating in low ambient conditions and reduces startup time

Fan grille design

- Discover a whole new level of performance with better heat dissipation and a modern look

Easy installation and service access

- Piping options in 4 directions: depending on the installation situation, installers can choose from 4 running pipe directions.
- Easier removal of front service cover: the screws you need to open/close the front service cover are all on the front side.

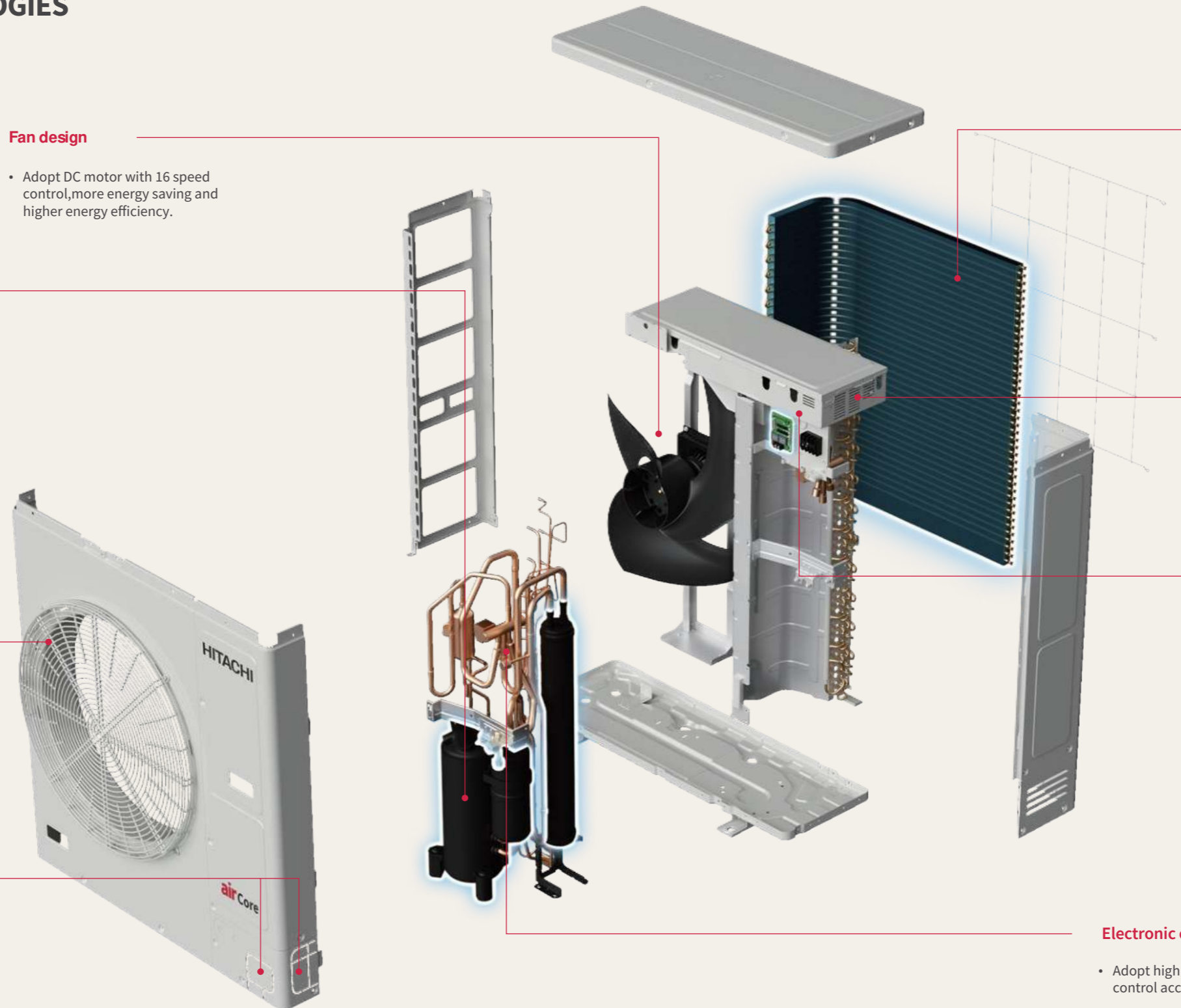

Excellent heat exchanger design

- Features a newly improved refrigerant path and a new fin shape, make the unit more efficient.

New printed circuit board

- With Hitachi's exclusive Compressor Control Technology, operation is more comfortable and consistent.

Electrical box protection

- Equipped with advanced electrical box protection, which is vital for safety as it prevents dust, moisture, and physical damage, ensuring proper function, easier maintenance, compliance with regulations, and ultimately extends component lifespan.

Electronic expansion valve

- Adopt high precision electronic expansion valves for higher control accuracy and more accurate temperature control.

Product features

(Standard series)

New Fan and Fan Grille Design

airCore 700 features both an enhanced fan and fan grille design compared to the previous generation product. The upgraded design not only improves heat discharge but also enhances the overall appearance, meeting the stringent requirements of engineers, business owners, and designers alike.

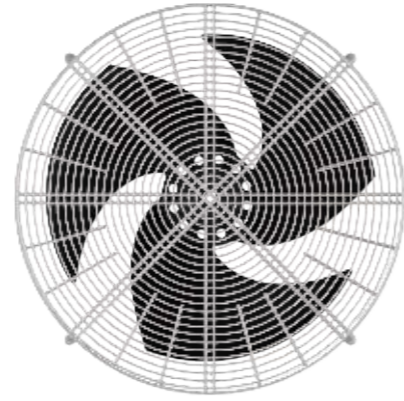

Wide Operation Range

Cooling operation range: 0°F/-18°C ~ 115°F/46°C
Heating operation range: -13°F/-25°C ~ 75°F/24°C

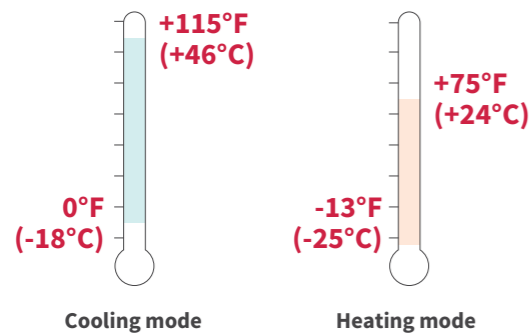

Base Pan Heater Capability

Base pan heater is installed on the chassis of the ODU to prevent ice buildup and increase heating capacity.

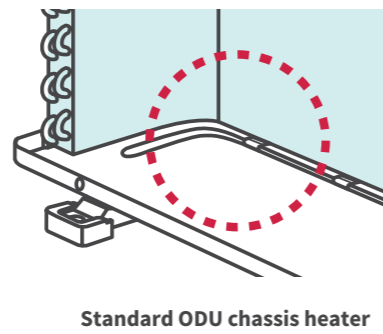

Superior Compressor and Pre-heating Function

- Adopting a new R32 DC inverter compressor results in greater energy efficiency.
- Pre-heating the compressor in low ambient conditions is accomplished through advanced multi-pulse control applied to the induction coil, core, rotor, and stator, eliminating the need for an external crankcase heater. This improvement enhances the efficiency of pre-heating in low ambient and reduces startup time.

Wide Capacity Range

airCore 700 boasts an expanded capacity range, reaching up to 48KW. Whether you're running a small business or searching for an AC unit for your home, the airCore700 is always the perfect choice.



R32 low GWP Refrigerant

Hitachi is committed to reducing the environmental impact of its products by using refrigerants with low Global Warming Potential (GWP). The **airCore700** split systems utilize R32, a low GWP refrigerant, as a replacement for the older R410a refrigerant. R32 offers improved energy efficiency and reduces emissions, allowing for smaller, more compact air conditioning systems that require less refrigerant overall. Its GWP is 675, significantly lower than that of R410a.

	Ozone Depletion Potential	Global Warming Potential
R32	0	675
R410A	0	2,090
R22	0.05	1,810

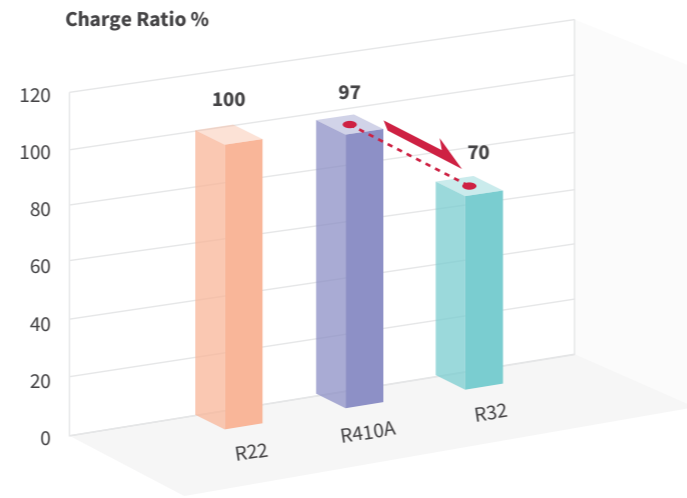

In case that all refrigerants have the performance equivalent to R22.

Energy Efficiency (Standard Series)

airCore700 has achieved higher energy efficiency. EER2 up to 15 Btu/h/W SEER2 up to 27 Btu/h/W



airCore700 has achieved high performance with Energy Star certification for the entire product line.

Ducted

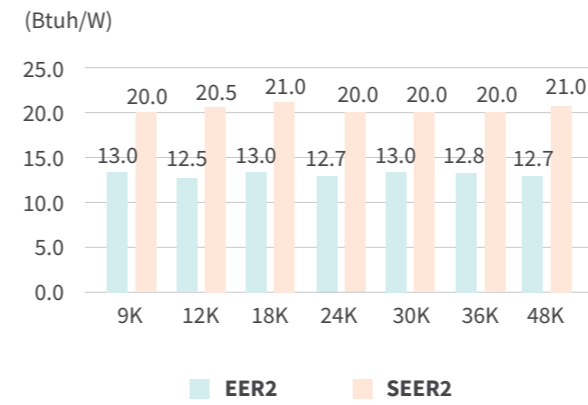

Cassette

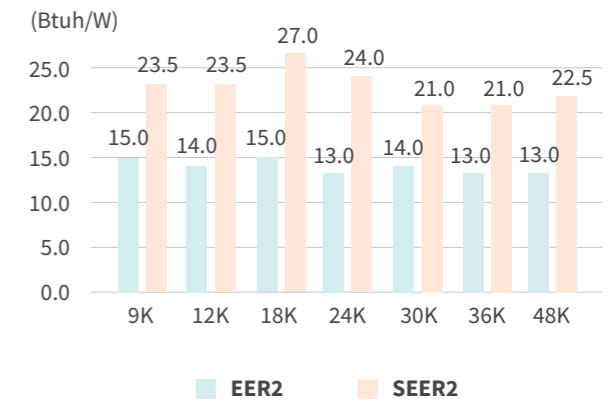

Ceiling suspended

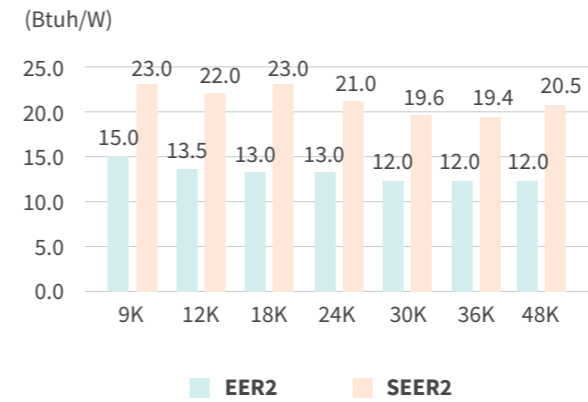

Air handling unit

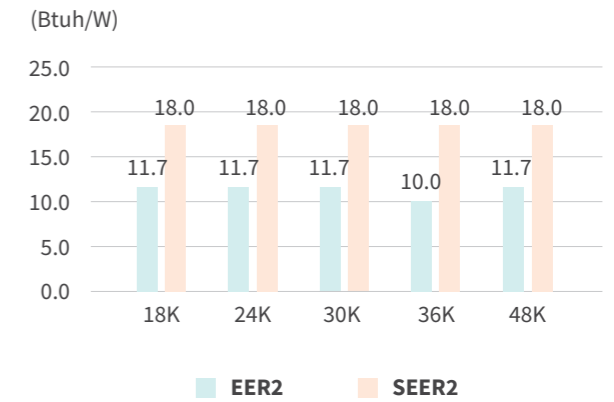

Highwall

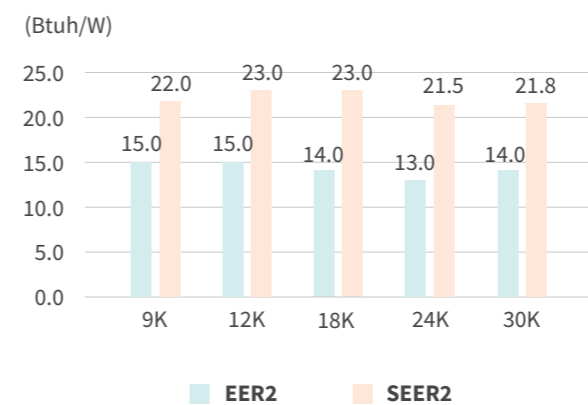

Flexibility for Easy Maintenance

The outdoor unit of **airCore 700** is designed with piping options available in four directions, allowing for flexible installation based on the specific situation. Installers have the choice of four running pipe direction options, providing adaptability for various installation scenarios. Additionally, the unit features an improved front service cover removal design; all the screws required to open or close the front service cover are conveniently located on the front side.

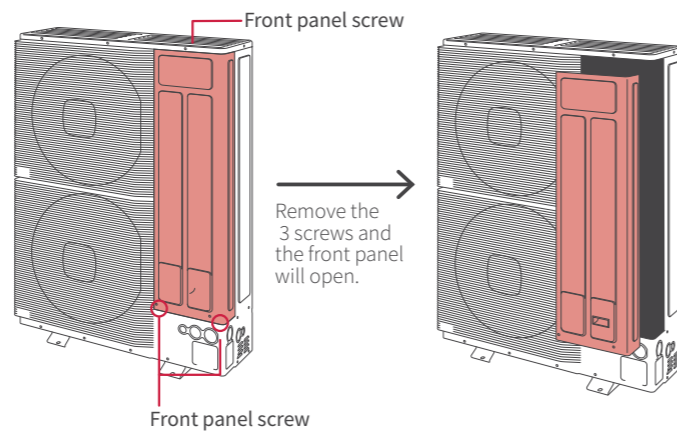
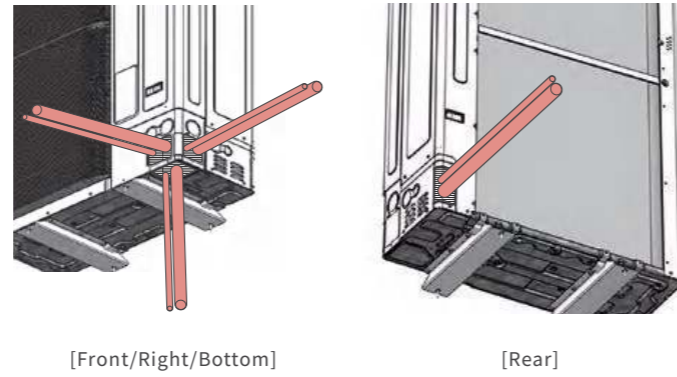

Electrical Box protection

Electrical box protection is vital for safety. Hitachi **airCore 700**, equipped with electrical box protection that can prevent dust, moisture, and physical damage, ensures proper function and easier maintenance, and, of course, meets compliance with regulations. Ultimately, it achieves the extension of the component lifespan.

Capable of Demand Response

- Interface provided for connection to DRED by the electrical utility provider.
- Capable of three modes: DRM1, DRM2, DRM3.
- Able to activate these modes accordingly during periods of peak electricity demand.

Night Quiet Operation

airCore 700 significantly reduces the noise levels of the outdoor unit and offers the feature to schedule night quiet operation is available for all indoor unit types. The ODU sound power level has decreased to 55-56 dB(A).



Long Piping and Large Height Difference

Accommodating up to **246ft(75m)** of piping run and **98.4ft(30m)** in height, this offers a great deal of flexibility in terms of installation.

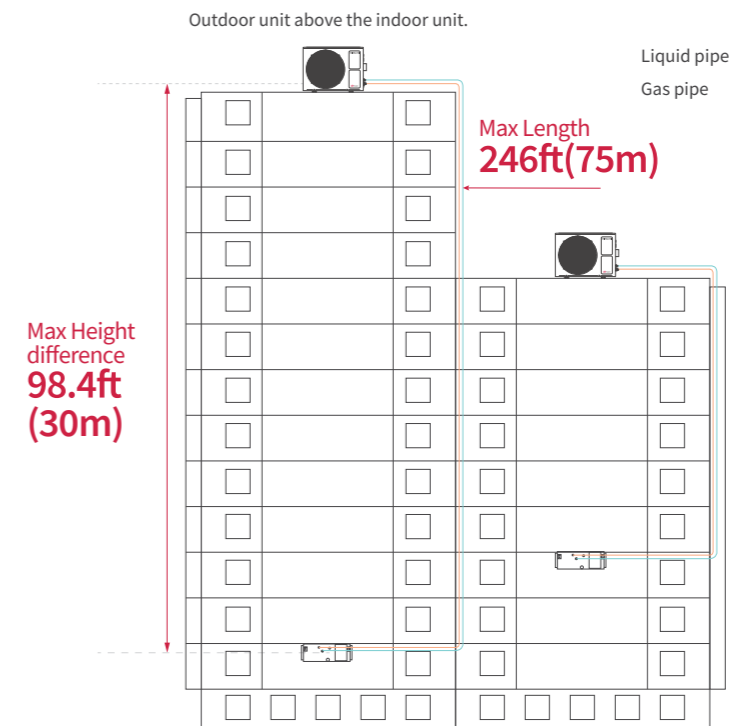

Note: only available to model 30K-48K

MSP Ducted		9K	12K	18K	24K	30K	36K	48K
Piping	Model	9K	12K	18K	24K	30K	36K	48K
Diameter (Liquid)	inch(mm)	1/4(Φ6.35)	1/4(Φ6.35)	1/4(Φ6.35)	1/4(Φ6.35)	3/8(Φ9.52)	3/8(Φ9.52)	3/8(Φ9.52)
Diameter (Gas)	inch(mm)	1/2(Φ12.7)	1/2(Φ12.7)	1/2(Φ12.7)	1/2(Φ12.7)	5/8(Φ15.88)	5/8(Φ15.88)	5/8(Φ15.88)
Max Length	ft(m)	164(50)	164(50)	164(50)	164(50)	246(75)	246(75)	246(75)
Max Height	ft(m)	98.4(30)	98.4(30)	98.4(30)	98.4(30)	98.4(30)	98.4(30)	98.4(30)

Product features

(HeatForce series)

Excellent heating capacity ability under low ambient condition

airCore 700 HeatForce series adopt a new R32 DC inverter compressor and feature a new heat exchange design, an improved refrigerant path and fin shape, making the unit achieve an incredible heating capacity even at low ambient temperature. It has been proven that HeatForce series can reach up to:

- 100% heating capacity ratio at 5°F/-15°C
- More than 70% heating capacity ratio at -13°F/-25°C

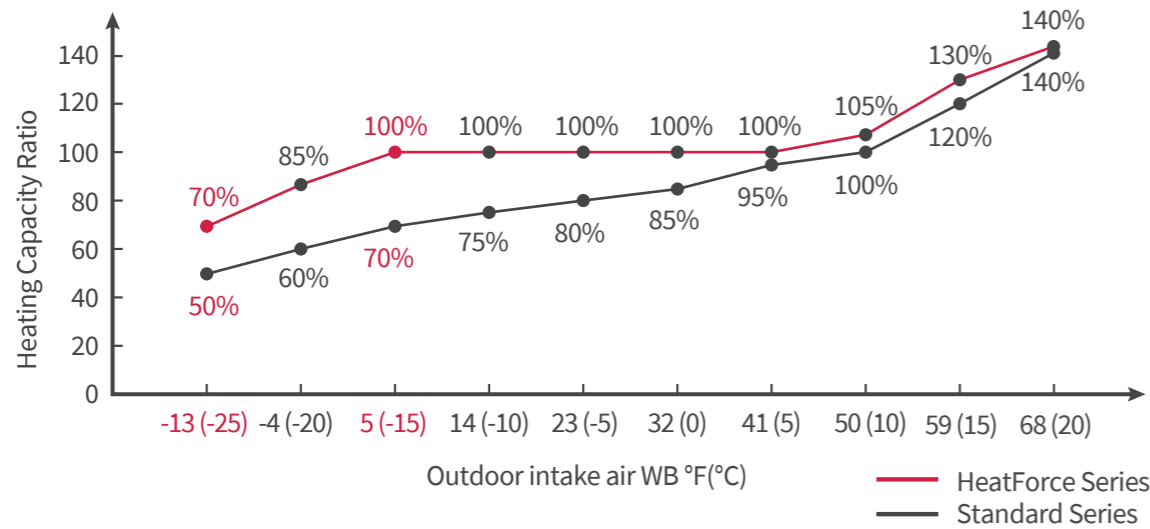

Note:
The chart shows how the unit capacity ratio varies with the ambient operating temperature.
Conditions:
• Pipe length/height difference: 25 ft (7.5 m)/0 ft (0 m)
• Fan speed: High
Capacity loss due to frost and defrost operation is not included.

Energy Efficiency (HeatForce Series)

airCore 700 HeatForce series has achieved higher heating performance and energy efficiency with Energy Star Cold Climate Certification.

EER2 up to 15 Btu/h/W

SEER2 up to 24.9 Btu/h/W

HSPF2 up to 11.5 Btu/h/W

Ducted (HeatForce Series)

(Btuh/W)

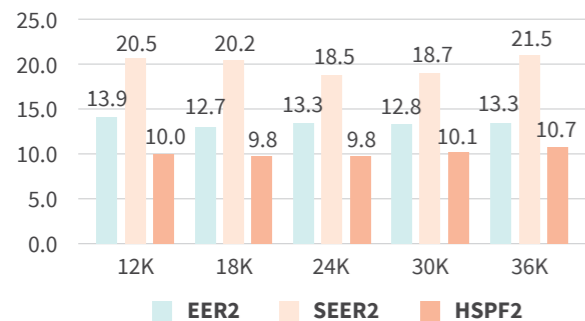

Cassette (HeatForce Series)

(Btuh/W)

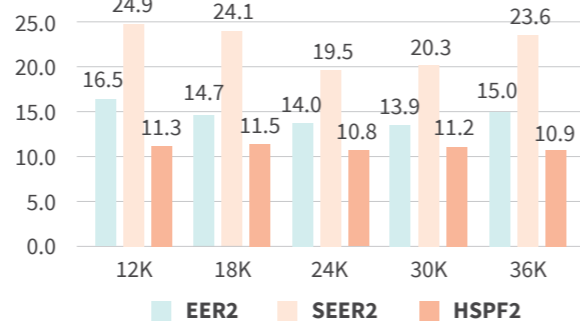

Long Piping and Large Height Difference

Accommodating up to **246ft(75m)** of piping run and **98.4ft(30m)** in height, this offers a great deal of flexibility in terms of installation.

MSP Ducted (HeatForce series)

Piping	Model	12K	18K	24K	30K	36K
Diameter (Liquid)	inch(mm)	1/4(Φ6.35)	1/4(Φ6.35)	3/8(Φ9.53)	3/8(Φ9.53)	3/8(Φ9.53)
Diameter (Gas)	inch(mm)	1/2(Φ12.7)	1/2(Φ12.7)	5/8(Φ15.88)	5/8(Φ15.88)	5/8(Φ15.88)
Max Length	ft(m)	164(50)	164(50)	246(75)	246(75)	246(75)
Max Height	ft(m)	98.4(30)	98.4(30)	98.4(30)	98.4(30)	98.4(30)

Low Ambient Cooling Design

Reserve one terminal for the heating belt to facilitate support for north American -40°F low ambient cooling requirement.



NA various climate condition*70% of DX Market requires low ambient cooling/heating



Indoor units

- 23 | FrostWash™
- 24 | Auxiliary Heater
- 25 | Ducted
 - 25 | Lineup
 - 25 | Ducted
- 27 | Cassette
 - 27 | Lineup
 - 28 | 4-way Cassette
 - 29 | Silent Iconic (optional)
 - 30 | Human Sensor Panel (optional)
- 37 | Ceiling Suspended
- 39 | Air Handling Unit
- 40 | Highwall



Indoor units

FrostWash™

Now available on airCore 700 Indoor Units

All indoor units including ducted, cassette, ceiling suspended, air handling unit and highwall, are equipped with FrostWash™.

This allows the unit to freeze dirt and dust trapped in the heat exchanger of the indoor unit, and then defrost it and dry it – effectively cleaning the hex and helping to safeguard long-term performance by maintaining good airflow.

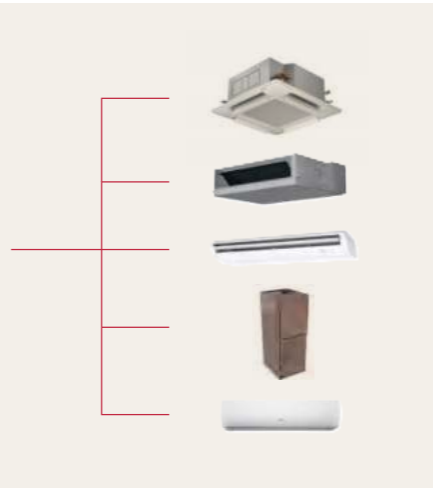
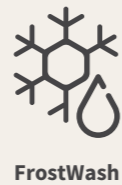

How does it work?

- FrostWash™ freezes the heat exchanger, capturing the dirt.
- When the frost melts, the dirt detaches from the fins.
- As a result, the air volume can be maintained over time, which contributes to a sustainable performance of the indoor unit and comfort.

FrostWash™ process can be activated manually or automatically at scheduled intervals.

* 1 Dirt removal depends on the usage environment.



Frostwash™ helps to maintain airflow performance

With Frostwash™ through the freezing defrosting and drying process, any dust and pollutants collected on the coil are discharged outside along with the condensate water, effectively maintaining the airflow performance of the indoor unit.

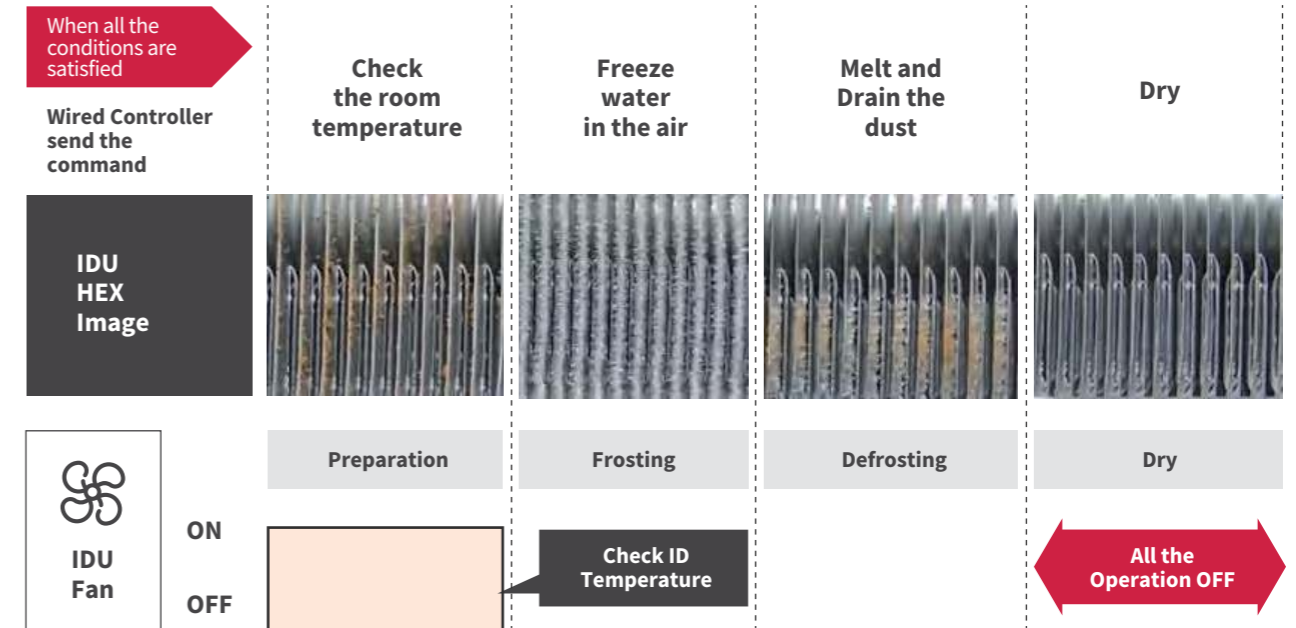

AUXILIARY HEATER

Built in auxiliary heater signal in the PCB board CN25.
Available for all indoor units.



- Notes:
- Can control of space temp difference or ambient restriction
 - Can control Duct Heaters, Heater kits, Baseboard heaters, etc.
 - CN25 is a 12VDC control signal and required a Pilot Duty Isolation Relay (field supplied)



Indoor units

DUCTED

Ducted
ESP range:
0.3-0.8 in.WG(75-200Pa)



9K, 12K

PPIM-B09UFA1DQ
 PPIM-B12UFA1DQ



18K, 24K, 30K

PPIM-B18UFA1DQ
 PPIM-B24UFA1DQ
 PPIM-B30UFA1DQ



36K, 48K

PPIM-B36UFA1DQ
 PPIM-B48UFA1DQ

Wide Range of ESP Ducted System

The ducted indoor unit is designed to handle an ESP range of 0.3~0.8 in.WG (75~200Pa). A wide ESP range means **airCore700** is suitable for spaces with many discrete areas, including corners and recesses. Multiple outlets can be connected to the ducted unit to ensure a uniform gust of air round a complex space. A system can set up in a short time and will run reliably into the future.

For example:
0.3 in.WG
(75Pa)

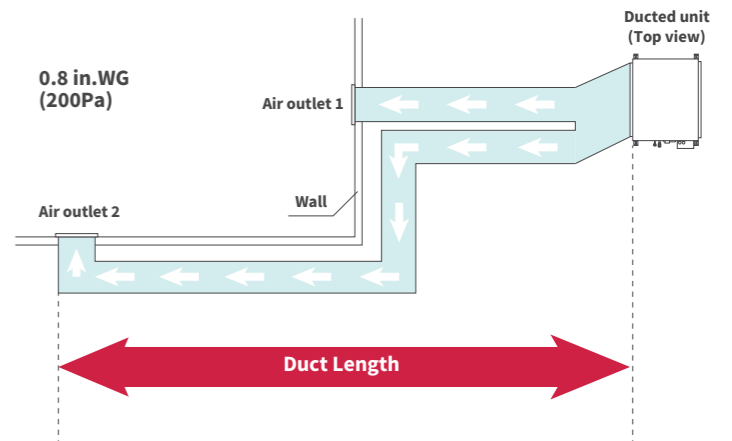
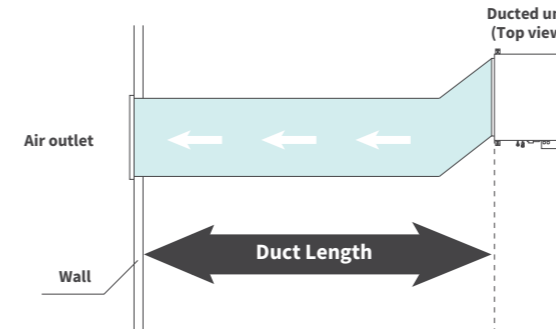

Automatic ESP Adjustment

Allow automatic setting of ESP level and ensure matching the corresponding fan speed according to the identified external static pressure and achieve rated airflow within 10% range.
 (setting via Service Menu in wired remote controller during commissioning)

Quiet Operation

airCore700 significantly reduces the noise levels of the outdoor unit and offers the feature to schedule night quiet operation is available for all indoor unit types. The well-balanced centrifugal fan also provides a quiet and efficient operation. The sound power level has decreased to 55dB. (Model 18K)

Indoor units

CASSETTE

4-WAY CASSETTE Standard Panel

PCIM-B09UFA1DQ
PCIM-B12UFA1DQ



PCI-B18UFA1DQ
PCI-B24UFA1DQ



PCI-B30UFA1DQ
PCI-B36UFA1DQ
PCI-B48UFA1DQ



4-WAY CASSETTE Silent Iconic (optional)

Silent Iconic Panel
(White)



4-WAY CASSETTE Human Sensor Panel (optional)



P-AP160NAE1
(Standard with Human Sensor Panel)



Indoor units

4-WAY CASSETTE

Airflow can be controlled by adjusting four louver individually

A comfortable air-conditioned environment can be achieved through various louver settings, which are available when combined with the wired controller. Air conditioning comfort is enhanced by using a louver control function to adjust louvers individually for better control of airflow direction. One option adjusts the louver horizontally to prevent direct airflow towards individuals, while another option provides individual swing operation to ensure optimal airflow distribution.

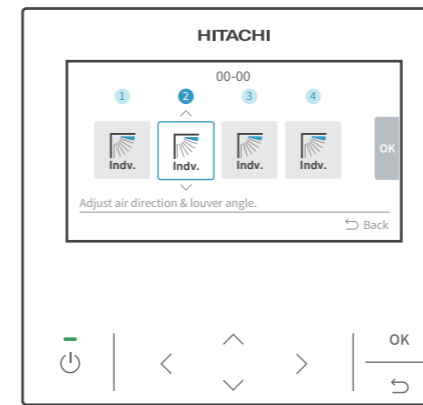

Easy setting of each louver airflow direction using Wired Controller

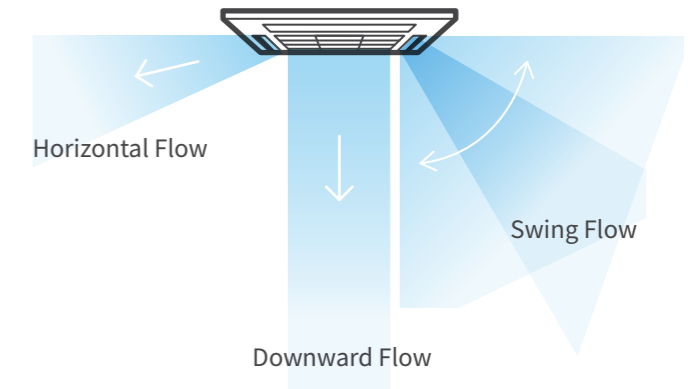

The airflow direction can be selected according to the situation.

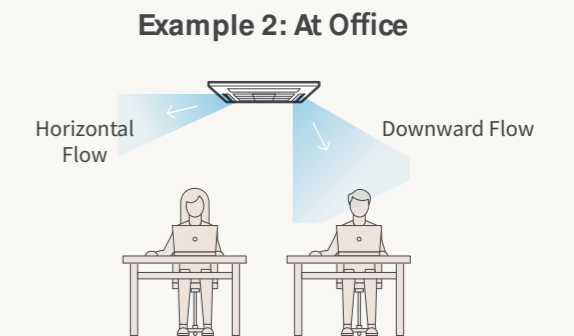
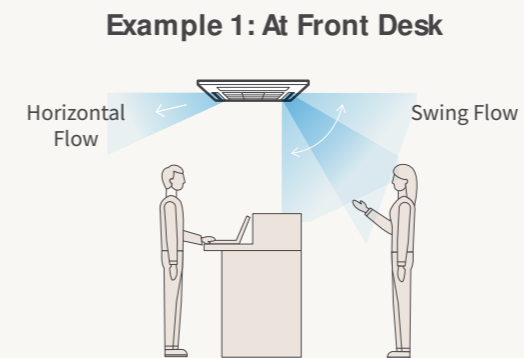

Indoor units

SILENT ICONIC (OPTIONAL)

Silent-Iconic™

4-way Cassette Design Panel

a cassette panel that offers design integration as discreet as a more expensive ducted system



iF Design Award 2020
Award Winning
(Discipline: Product)

A new option

"Silent-Iconic"

Designed to match the interior, in harmony with the space. Compared with the ceiling-duct-type, the installation cost can be reduced.



The traditional selection

Ceiling Mounted Duct Type

Using this type, you can create a sense of luxury without being noticeable, but its construction costs are relatively high.



or

4-way Cassette type

Although the installation cost can be reduced, it may be difficult to match with the surrounding space due to the large presence of the indoor unit.



The design is well-matched to the space

It is designed to harmonize with the space by using a discrete low-profile air grille and darkening the contact space between the grille and the unit frame.



Low-profile air grille

Space between the air grille and unit frame



It is easy to clean the filter

It is easy to clean the filter by using the selecting the option with the elevation grille which enables the air grille to be lowered to floor level for cleaning through the use of a powered motor.

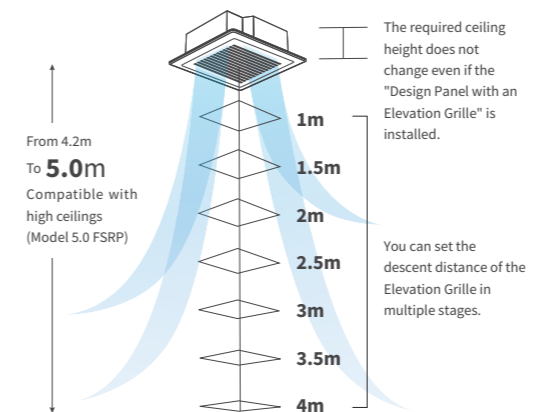

It is easy to install

The sliding corners make it easier to fasten the panel to the ceiling surface using screws.



Indirect airflow option

Using the compatible controller and motion sensor kit, users may select from direct or indirect airflow: indirect airflow detects the presence of people in the space and directs airflow around them so they do not directly feel the airflow.

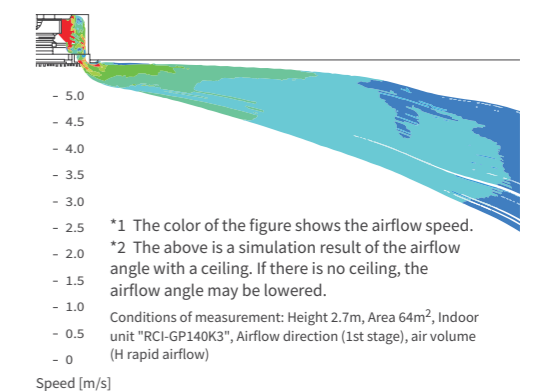

Connection with ceiling surface

By using a low-profile frame connected to the ceiling, the unit is less visible, and harmonization with the ceiling surface is further enhanced.



Silent-Iconic 4-way Cassette Design Panel

Indoor units

HUMAN SENSOR PANEL (OPTIONAL)

Let occupants can choose whether they want to directly feel airflow

The presence of occupants is detected through a motion sensor which divides the room into 4 zones – one for each louvre. For each of the 4 zones served by a cassette, air can be served either Direct or Indirect. Therefore one zone could receive direct airflow while another has indirect airflow, catering for different personal preferences of people occupying the same area.

- Choose Direct air flow: the Twin-Sense cassette will target the corners with human activity.
- Choose Indirect air flow: Twin-Sense cassette will avoid the corners where occupants are detected.

Indirect air flow

Horizontal air flow, for circulation above and around occupants without air blowing directly on them.

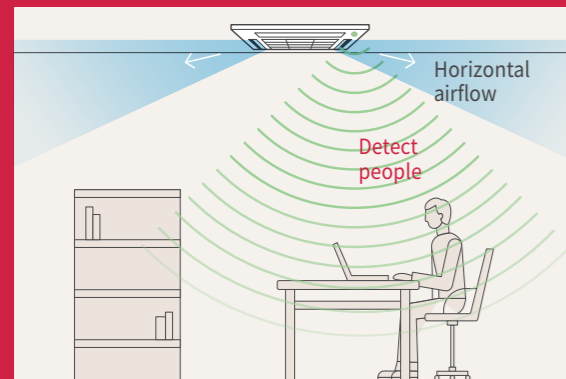

Ideal in places where occupants remain seated for a long time: restaurants, offices, theaters...

Direct air flow

Auto swing of louvers ensures that every occupant can feel the air blowing.

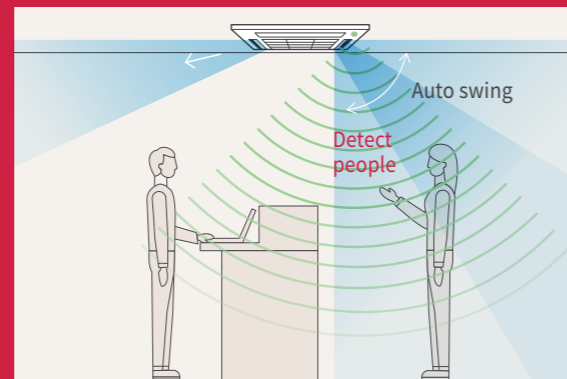

Ideal in places where occupants need to quickly warm up or cool down: entrance areas and corridors, hotel lobby...

Notes:

When room vacancy is detected, the air is directed in the way the controller (PC-ARFG) is set up. (Note) 4-zone motion sensor may not be effective in the following cases:

- If the room is occupied but the movement is minimal, the system might consider the room as vacant.
- If an object with a temperature different to the surrounding is in motion, it might be considered as human presence.

Occupancy sensing technology

With **CrowdSense** technology, select units can determine how many people are in a space and adjust the cooling or heating capacity accordingly, so the room will never get too hot or cold, whether it's crowded or almost empty

- Hitachi Twin-Sense cassette detects the crowd's arrival or departure.
- Using AI, the cassette can anticipate the addition or reduction of human heat sources and immediately adjusts the air conditioning accordingly.

Requires optional motion sensor kit available for many Cassette and Ceiling Suspended models

Crowd-Sense action during cooling.

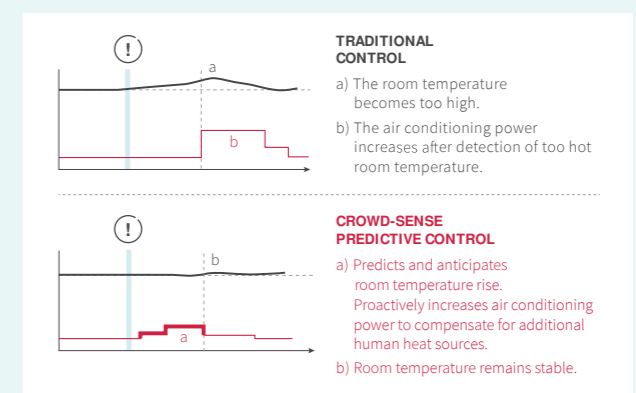
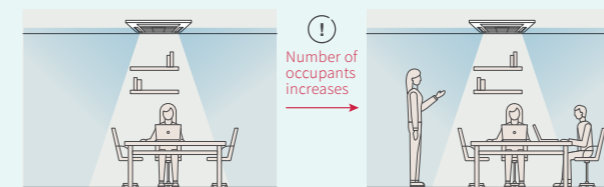

Crowd-Sense action during heating.

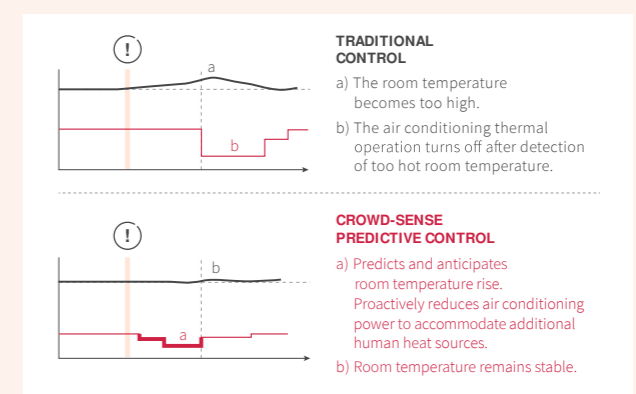
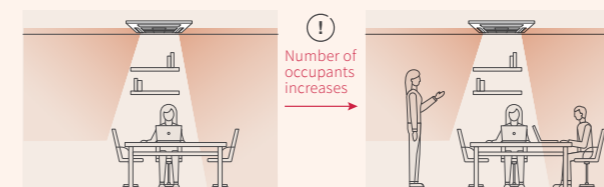

----- Target set temperature — Power — Room temperature — Time

Crowd-Sense may not be effective or might be less effective in the following cases:

- Multiple indoor units are in operation in the same zone.
- The difference between the radiant temperature of the room (floor and walls) and the radiant temperature of the human body is minimal.
- The room temperature is high before operation.
- During the heating process, when the number of occupants decreases.

Indoor units

HUMAN SENSOR PANEL (OPTIONAL)

No more cold feet

In cooling scenarios, **FloorSense Cool**^{*1} can prevent the floor area from overcooling by controlling airflow and cooling capacity so that the air at floor level does not get as cool as air above knee height.

*1 Available on select Cassette models. Requires optional cassette panel with Motion Sensor & Radiant Temperature Sensor.

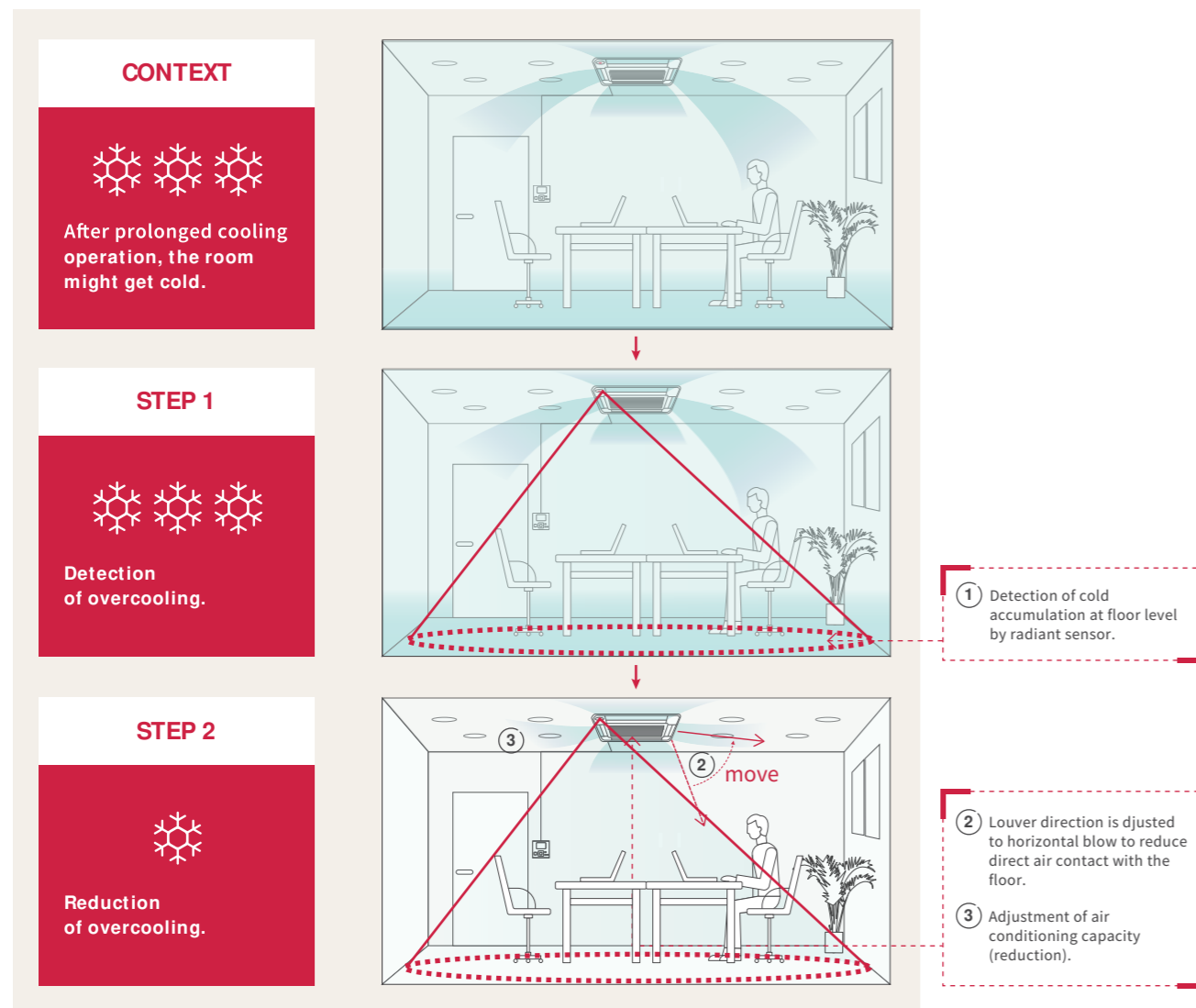

Compact Design

With a unit height of 238~288mm, easy for installation in tight clearance spaces.



Indoor units

HUMAN SENSOR PANEL (OPTIONAL)

FeetWarm (for heating operation) - head to toe comfort during winter

In room heating scenarios, it's common to hear users complain of cold feet because heat naturally rises. **FeetWarm** helps to solve this problem by optimizing airflow in heating mode to ensure that the leg zone is consistently heated.

Available on select Cassette models. Requires optional cassette panel with Motion Sensor & Radiant Temperature Sensor.

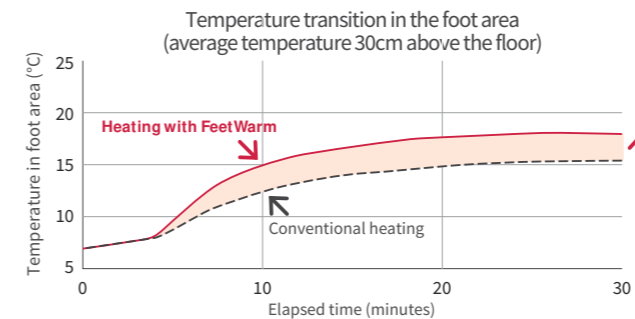

FeetWarm's boasts 4 intelligent features:

- Thanks to the Twin-Sense radiant sensor, it can detect heat stratification effects inside the room, which usually cause the floor and lower levels to be cooler.
- A 2-step action to first create consistent warmth, then to maintain it.
- Advanced heat air flow optimization, by sophisticated control of the 4-way cassette's individual louvers.
- The lower levels of the room (floor level, feet level, leg level) reach desired temperatures, for total comfort.

How does it work?

Step 1.

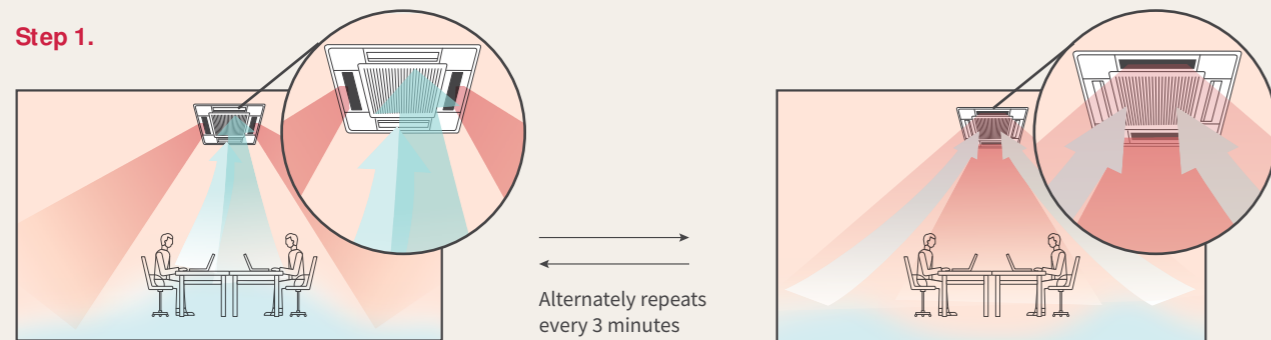

- ① The radiant sensor detects a temperature drop in the floor and around your feet.
- ② The cassette partially closes two louvers automatically.
- ③ The air flow strengthens through the two remaining open louvers, and targets the floor to warm it up quickly*1.
- ④ Louver opening alternate every three minutes from wide open to partially closed to cover a wider floor area.
- ⑤ As louver openings close, suction increases in the central inlet grill for a faster warming effect.

*1 Caution: when the indoor unit changes to heating, the sudden change in air flow might cause occupants to feel a cold draft sensation.

Effect of FeetWarm - Step 1.

Temperature distribution around the area of the feet (30min after air conditioning heating operation starts).

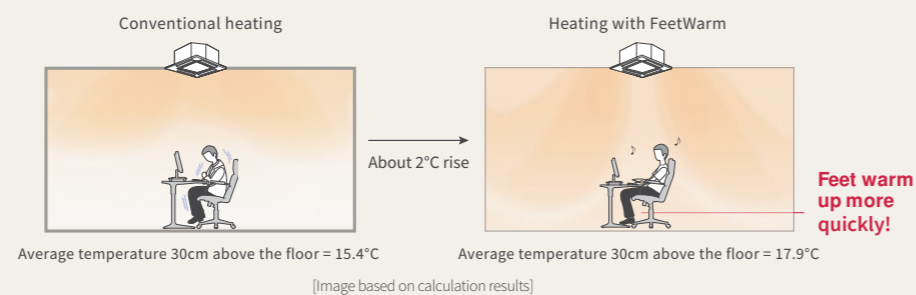

Step 2.

- ① When the radiant temperature sensor detects that the lower level is no longer cold, FeetWarm shifts to its second step for a more even temperature everywhere in the room.
- ② One louver remains closed.
- ③ Three remaining open louvers follow Auto-Swing air flow direction, continuously moving up/down. This leads to faster circulation of the warm air in all areas of the room.
- ④ Suction of colder air remains facilitated thanks to the one partially closed louver.

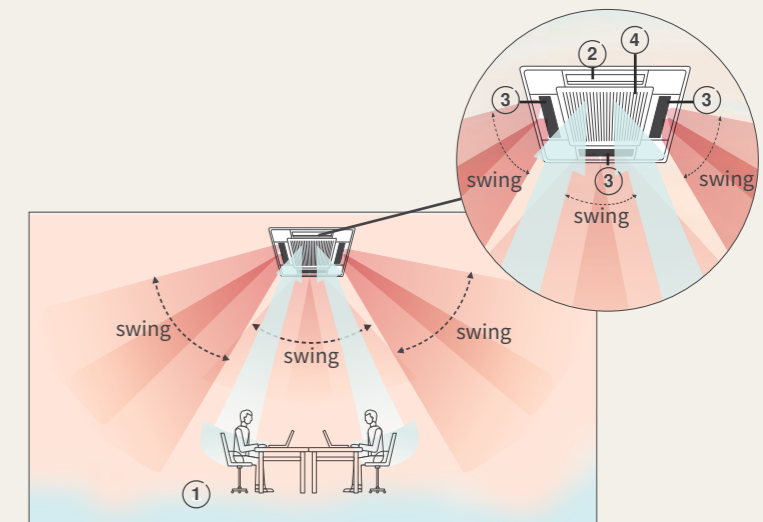

Effect of FeetWarm - Step 2.

Temperature distribution around the area of the feet (30min after air conditioning heating operation starts).

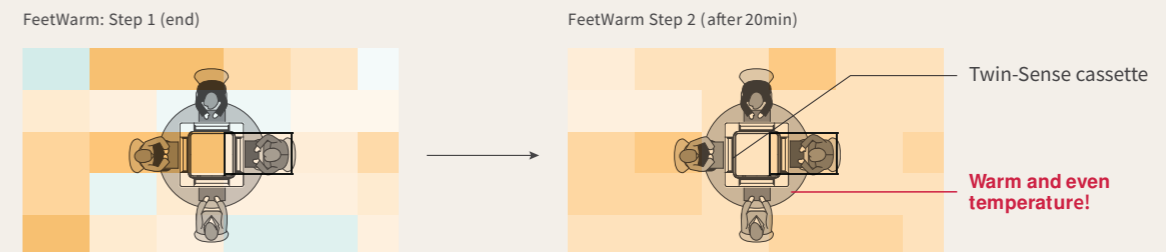

[Measurement condition Based on Hitachi research].
See simulation result under the following conditions above. Unit capacity: 8.0KW, room size: "height 3.2m, length 6.3m, width 6.3m", indoor initial temperature: 7°C, outdoor temperature: 7°C, indoor airflow temperature: 30°C for 0-5 minutes, Gradually rise from 30°C to 40°C after 5 minutes, Multi-function remote control setting: Airflow heat control "effective / long".
(Note) The effect varies depending on the size of the room and the load.



Indoor units

CEILING SUSPENDED

Unavailable for HeatForce series



9K, 12K

PPFC-B09UFA1DQ
PPFC-B12UFA1DQ



18K

PPFC-B18UFA1DQ



24K, 30K, 36K, 48K

PPFC-B24UFA1DQ
PPFC-B30UFA1DQ
PPFC-B36UFA1DQ
PPFC-B48UFA1DQ

Auto-swing

The ceiling suspended unit offers an auto-swing function. The louvers are capable of horizontal auto-swing, allowing them to move from side to side or be set to a stationary position. This feature ensures that the cooling flow is evenly distributed to every corner of the room, providing exceptional comfort without any worries.

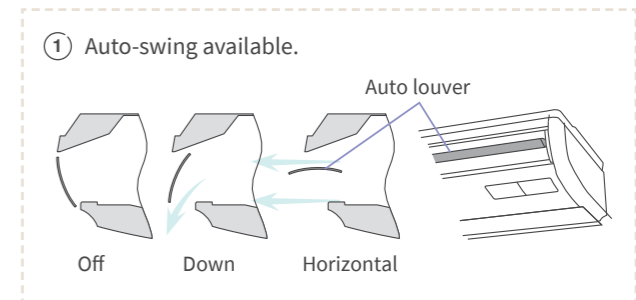

Motion Sensor (Optional)

The ceiling suspended indoor unit is designed to be compatible with an optional motion sensor device. With a sensor distance of up to 7m, this unit can detect occupancy in the room and automatically control the AC, turning it on or off accordingly. By avoiding unnecessary operation when the room is unoccupied, this feature contributes to energy conservation and helps reduce electric bills.

- ② 7m reach motion sensor (option: SOR-NEP).
Use a motion sensor for extra savings when the room is vacant.

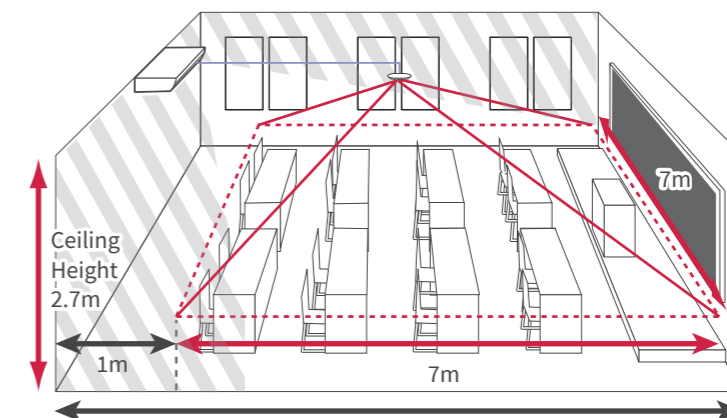

Indoor units

AIR HANDLING UNIT



JPE18B3XB2HS1A
 JPE24B3XC2HS1A
 JPE30B3XD2HS1A
 JPE36B3XD2HS1A
 JPE48C3XG2HS1A

Five-speed standard ECM blower motor

The unit is compatible with a five-speed standard ECM motor that delivers increased airflow and reduces blower wattage by 10%, while also providing enhanced system compatibility.

Designed for easy installation and service

A casing size of 20.5 inches with smooth sides and rigid construction makes it easy to install in attics and tight applications. Front-facing components, a slide-out blower, laser-cut knockouts, and integrated duct flanges can shorten installation time. The unit also offers an electric heat kit. 8HK field-installed models are available for easy installation and service applications.

Long lasting quality

Structural components are made of post-powder painted steel or galvanized steel to prevent corrosion. The next-generation insulation and gasket design reduces thermal transmission paths and minimizes sweating.

Cabinet air leakage

Less than 2% at 1 in. W.C. external static pressure when tested in accordance with ASHRAE Standard 193.

A2L refrigerant ready

An R32 refrigerant detection sensor (RDS) is factory installed.



Indoor units

HIGH WALL



PPK-B09UFA1DQ



PPK-B12UFA1DQ
 PPK-B18UFA1DQ



PPK-B24UFA1DQ
 PPK-B30UFA1DQ



24-hour Timer ON and OFF

This Timer can be set to automatically turn the unit on or off within a 24-hour period.

Mute operation

The excellent fan design enables smooth airflow with minimum noise.

Emergency button

Pressing the emergency button can start or stop the unit, and it can also reset the filter indication.

Powerful mode from hand-held remote controller (HHRC)

In cooling or heating mode, the unit can raise or lower the temperature immediately by pressing the 'Powerful' button on the HHRC. Activating 'Powerful' will change the temperature setting for 30 minutes and automatically adjust the airflow rate.

Controllers

41 | Controllers

- 42 | Wired Remote Controller (WRC)
- 43 | Hand-held Remote Control (HHRC)
- 44 | IR Receiver

45 | Central Stations

- 45 | Mini Central Controller
- 45 | Large Central Controller
- 46 | VRF Central Touchscreen Controller & Extension Adapter
- 47 | BMS ADAPTER for LonWork®

48 | Apps

- 49 | airCloud Go
- 50 | airCloud Tap

51 | H-LINK

Controllers

WIRED REMOTE CONTROLLER (WRC)

airPoint Room 700 (CIW03-H)



A new generation of room controllers with user friendly UX/UI

- Colorful screen
- Award winning design
- Visual interface
- Simplified navigation
- Access to latest Hitachi features
- Optimized for installers too
- Special functions for Hotels
- Two controllers can be connected to one IDU
- Compatible with airCloud Tap
- Controls up to 16 indoor units



reddot winner 2021



Backup System Setting

NEW

- Rotation Operation
- Backup operation when abnormality occurs
- Backup operation in high load
- Settings on the controller is quite simple

Model	CIW03-H
Product Name	airPoint Room 700
Dimension(mm)	W 120 × H 120* × D 16.5(thinnest part) W 120× H 120* × D 21.5(thickest part)
Weight	180g (Approx.)
Installation Method	Installed on the wall or switch box
Power supply	DC power supply from indoor Unit
Temperature Condition	0~40°C(40-104°F)
Humidity Condition	35~90% (non-condensation)
Embedded NFC	Yes

Controllers

HANDHELD REMOTE CONTROLLER (HHRC) (OPTIONAL)

PC-LH8QE

Dimensions: 180x48x22.15 mm
Weight: 0.156 kg

Powerful, innovative & compact

- Designed to embody a fresh and innovative appearance
- Modular concept and seamlessly integrated across the entire region
- Featuring an intuitive design and a cutting-edge segment display
- Featuring a larger LCD measuring 31x50 mm with backlight.
- Covering both basic and advanced features, including Run/Stop, Up/Down, Left/Right, Louver settings, Cooling/Heating, Dry, and Timer.



IR RECEIVER (OPTIONAL)

Simultaneous control of multiple units

One IR receiver can simultaneously control multiple indoor units (up to 16 units). In the case of multiple indoor units installed in a large room, a single wireless remote controller can operate and stop all of them. Moreover, two IR receivers can be connected to one IDU.

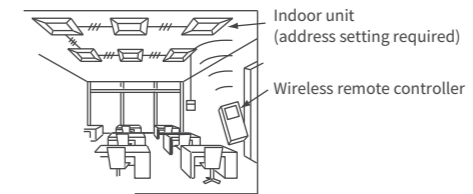

NOTE:
When multiple units are being controlled simultaneously, all indoor units should be placed in one room. If using a single wireless remote controller to manage air conditioners across more than two rooms, it is possible to forget to turn off one.

Compatible IDU models

Indoor Unit Type	Model Name	IR receiver
Ducted	PPIM-B18UFA1DQ	PC-ALHZ5Q
	PPIM-B24UFA1DQ	
	PPIM-B30UFA1DQ	
	PPIM-B36UFA1DQ	
	PPIM-B48UFA1DQ	
4-Way Cassette	PCIM-B09UFA1DQ	PC-ALHC5Q
	PCIM-B12UFA1DQ	
	PCI-B18UFA1DQ	PC-ALH5Q
	PCI-B24UFA1DQ	
	PCI-B30UFA1DQ	
	PCI-B36UFA1DQ	
	PCI-B48UFA1DQ	
	PCI-B48UFA1DQ	

GVBL Decoration Film

Powerful

- To raise or lower the temperature immediately in cooling & heating mode

Sleep

- A more comfortable environment for sleep
- Sleep time is fixed as 8 hours

Auto FrostWash Enable/Disable

PC-ALHZ5Q, PC-ALHC5Q, PC-ALH5Q

Model	PC-ALHZ5Q	PC-ALHC5Q	PC-ALH5Q
Dimension(mm)	120*90*28mm	154.5*154.5*28.7mm	203*203*35.8mm
Weight	255g(Approx.)	231.5g(Approx.)	188g(Approx.)
Product Name	Wireless Receiver Kit	Wireless Receiver Kit	Wireless Receiver Kit
Installation Method	Installed on the wall or switch box	Installed on indoor unit panel	Installed on indoor unit panel
Power supply	DC power supply from indoor Unit	DC power supply from indoor Unit	DC power supply from indoor Unit
Max. Distance	RC-Link, 300m	RC-Link, 300m	RC-Link, 300m
Max. number of connected indoor	16	16	16
Temperature Condition	0~40°C(40~104°F)	0~40°C(40~104°F)	0~40°C(40~104°F)
Humidity Condition	35~90% (non-condensation)	35~90% (non-condensation)	35~90% (non-condensation)

Controllers

CENTRAL STATIONS

Mini Central Controller CCM01



Features and Benefits

- Controls up to 32 groups of indoor units (maximum 160 units)
- Easy-to-use touchscreen interface
- Color-coded graphics for quick reference
- Set up to 10 on/off times per day
- Up to 8 Mini Controllers can be connected to the H-LINK II segment
- External input/output terminals are provided as standard. External signals enable the following options:
 - Central operation/stop
 - Demand control
 - Emergency stop
 - Central operation output
 - Central alarm output

Model Number	CCM01
Model Type	Mini Central Controller
	Run/Stop
	Mode
	Temperature
	Fan Speed
	Louver Angle
Control Functions	Filter Sign Reset
	Schedule Timer Setting
	Holiday Setting
	Temp. Setpoint Range of Remote Control
	Group Name Register
	Accumulated Operation Time
	Daylight Saving Time Setting

Power Specification

Rated Power Supply	24VAC, 60Hz
Electrical Power Consumption	10W (Max.)

Large Central Controller CCL01



Features and Benefits

- Controls up to 64 groups of indoor units (maximum 160 units)
- Easy-to-use touchscreen interface
- Color-coded graphics for quick reference
- Set up to 10 on/off times per day
- Up to 8 large controllers can be connected to the H-LINK II segment
- External input/output terminals are provided as standard.
- External signals enable the following options:
 - Central operation/stop
 - Demand control
 - Emergency stop
 - Central operation output
 - Central alarm output

Model Number	CCL01
Model Type	Large Central Controller
	Run/Stop
	Mode
	Temperature
	Fan Speed
	Louver Angle
Control Functions	Filter Sign Reset
	Schedule Timer Setting
	Holiday Setting
	Temp. Setpoint Range of Remote Control
	Group Name Register
	Accumulated Operation Time
	Daylight Saving Time Setting

Power Specification

Rated Power Supply	24VAC, 60Hz
Electrical Power Consumption	10W (Max.)

VRF Central Touchscreen Controller CCXL02



Extension Adapter CCXLA02



Note: Does not coexist with HBN200-PRO VRF Gateway

Features and Benefits

- Remote monitor and operate central controller with Remote Access Software
- Tenant metering with optional Energy Calculation Software
- Trend graphs of running time and temperature setpoint
- Function selection of indoor unit groups through central controller
- Management of up to 2,048 groups (2,560 indoor units) with extension adapter
- 12.1-inch color capacitive touch screen LCD for easy operation
- Supports SD memory card and USB flash device for data export
- Customizable display image size with zone selection options
- External input/output terminals for controlling or monitoring external equipment
- 7-day pattern and seasonal (Winter/Summer) scheduling with exception day or holidays

VRF Central Touchscreen Controller Hardware Specification

Dimensions (W×H×D)	14-5/8 × 8-15/16 × 1-1/4 + 1-1/8 (molded in wall) inch (372 × 227.2 × 32.5 + 27.8 (molded in wall) mm)
Net Weight	7.7lbs. (3.5kg)
Installation Condition	For indoor use only. Applicable for a wall mounted.
Clock Accuracy	± 70 seconds/month
Ambient Temperature	32~104°F (0~40°C)
Ambient Humidity	20-85% RH (No condensation)
Display	12.1 inch TFT color liquid crystal display
Power Supply	AC24V ± 10% (60Hz) (Transformer 55VA (Min.))
Power Consumption	50W (Max.) (55VA (Max.))

Extension Adapter Hardware Specification

Dimensions (W×H×D)	W: 10-1/16 (255.6) x H: 6-1/8 (155) x D: 2-13/16 (72)
Net Weight	Approx. 3.3 lb (1.5kg)
Installation Place	For Indoor Installation Only For Wall Mount or Wall Built-in
Ambient Temperature	32~104°F (0~40°C)
Ambient Humidity	20-80%RH (No Condensation)
Rated Power Supply	24VAC ± 10%, 60Hz (Transformer 55VA (Min.))
Power Consumption	Maximum 10W (12VA)

Controllers

CENTRAL STATIONS

VRF Gateway

HBN200-PRO



Note: Does not coexist with CCXL02 Central Controller

Extension Adapter Hardware Specification

Dimensions (WxHxD)	90 x 156 x 35 [mm] / 3.54 x 6.14 x 1.33 ["]
Net Weight	A266 [gr] / 0.58 [lbs]
Installation Condition	FDIN rail / wall
Input	8 bit encoded analog input
Ambient Temperature	-20°C ~ 70°C / -4°F ~ 158°F
Ambient Humidity	0% ~ 98% non-condensing
LCD	2.8" / 240 x 320 / 262K
Power Supply	5V/300mA (via mini USB); 12V/200mA; 24V/120mA
Wiring Length RS485	1000 [m] / 3300 [ft]
	Connection to the 2-wired HVAC bus (Direct HVAC Connection)
	RS-485 communication line (Modbus(A/B))
Communication functions	100Mbps (Ethernet)
	12Mbps (USB Host)
	12Mbps (USB Device)

Features and Benefits

- HBN200-PRO VRF Gateway has a built-in touchscreen LCD for easy configuration of:
 - a. IP for BACnet IP or Modbus IP
 - b. BACnet Instance Identifier
 - c. Configuration of the RS485 L3 port for the choice to use Modbus RTU or BACnet ms/tp
 - d. Baud rate configuration
 - e. Connected unit status, simplified control of IDU
- HBN200-PRO VRF Gateway has 2 H-Link ports, each can connect to 160 indoor units, max total of 255 units combined.
- HBN200-PRO VRF Gateway has exposed the advanced monitoring points of the Service Checker data to be integrated into the BAS for use in the diagnostics and performance of the IDU's and ODU's

BMS ADAPTER for LonWork®

CLW01



CONTROL UP TO 64 / 32 / 16 RCG (Remote Control Group)

CLW01 offers various control/monitor modes:

- Standard (64 RCG)
- Option A (64 RCG)
- Option B (32 RCG)
- Option C (16 RCG)

Each mode has different control/monitor points and RCG configurations.

General Functions

- Run / Stop
- Operation Mode
- Temperature Setting / Status
- Fan Speed
- Louver Setting
- Prohibited / Permitted RC Operation
- Filter Sign / Reset
- Alarm Code
- Thermo Status

Hardware Specifications

Upper-level communication (BMS Side / BMS Protocol)	LonTalk
Lower-level communication (AC side)	H-Link II
Central Controller used together with the same H-Link	EZ, Mini (Either EZ or Mini)
Number of adapters used together with the same H-Link	Standard - 1 Option A - 1 Option B - 2 Option C - 4
Dimensions (H x W x D)	** 92mm x 110mm x 124mm
Weight	670g
Power	AC 220-240V 50/60Hz

Note: LonWork adapter can not be used with Central Controller EX.

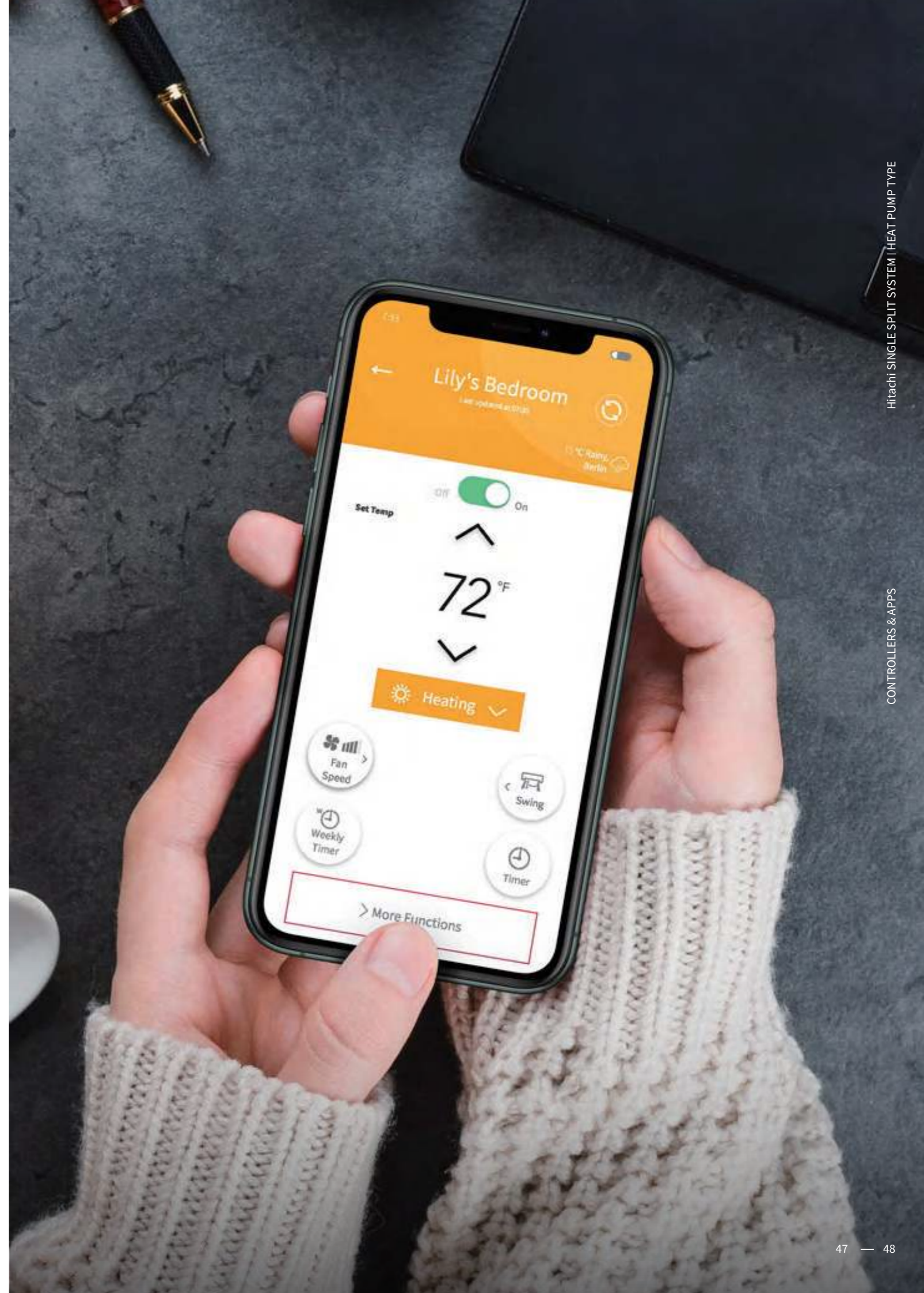

Controllers

APPS | airCloud Go

Remotely control individual indoor units.

 **airCloud Go**
Connect your Hitachi air conditioners to airCloud Go via wifi.

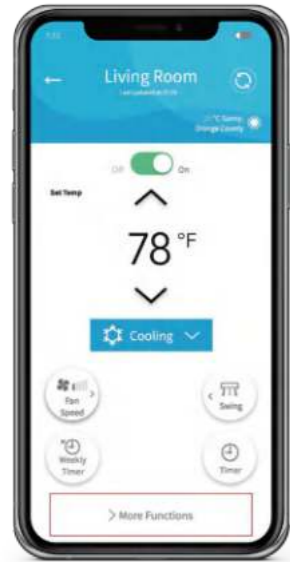

Control your AC from anywhere!

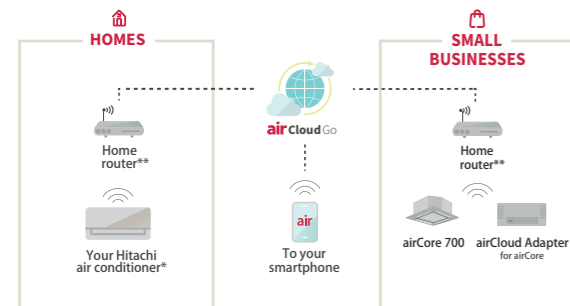

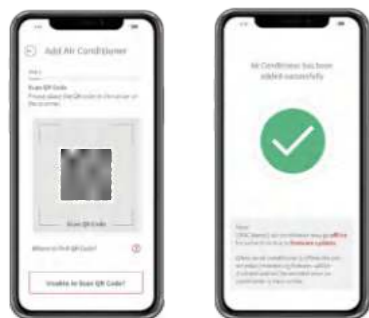

Quick set up QR code recognition enables you to pair your app to your air conditioner in an instant.



Enjoy freedom and convenience to save energy & improve comfort.

 **Up to 20 units connection**
Do you manage Hitachi air conditioners in multiple locations? From your airCloud Go account, you can access and control up to 20 air conditioners.

 **FrostWash activation**
With airCloud Go, you can activate Hitachi exclusive self-cleaning function while you're away. Contribute to preserving the indoor air quality.

 **Share access with multiple users**
airCloud Go allows you to give access to up to 20 people. You can choose to apply restrictions.

Notes:
(1) Compatibility varies per Hitachi air conditioner models, some requires an adapter.
(2) airCore 700 requires adapter GA-WFG-N to be compatible with airCloud Go.

 **App available in 20 languages**
Chinese (traditional and simplified), Croatian, Czech, Dutch, English, French, German, Greek, Hungarian, Indonesian, Italian, Malay, Polish, Portuguese, Romanian, Slovenian, Spanish, Thai, Vietnamese.



visit hitachiaircon.com

APPS | airCloud Tap

Convenient tools for quick installation and service.

 **airCloud Tap (NFC)**
for using with WRC (CIW03-H)

Improved serviceability with airCloud Tap

"airCloud Tap" is used setting the controller from smartphone easily.

To download the "airCloud Tap" application, search for it on the "App Store"^{*1} or "Google Play"^{*2}. Alternatively, you can scan the code provided below with your smartphone to directly access the application.

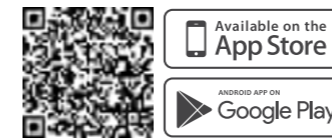

*1 App Store® is a service mark of Apple Inc.
*2 Google Play and the Google Play logo are trademarks of Google LLC.



Read & Write settings with your phone
4 steps:

Less button to press
· No need to stay close to the controller during editing
· Easier to edit on the phone rather than controller
· More complete descriptions of functionalities

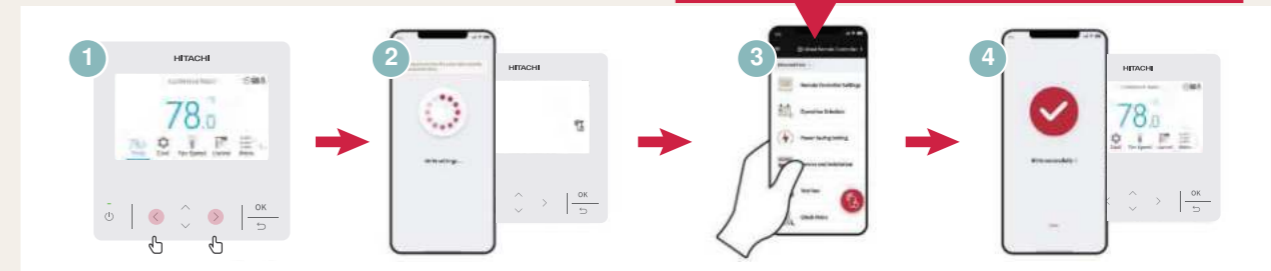

1 Activate the NFC function on the controller.

2 Open the airCloud Tap app and tap the controller with your phone to read the settings.

3 Edit the desired settings on your phone via airCloud Tap app.

4 Tap the controller again with your phone to write the new settings and apply them to the controller.

Controllers

APPS | UNIT COMPATIBLE

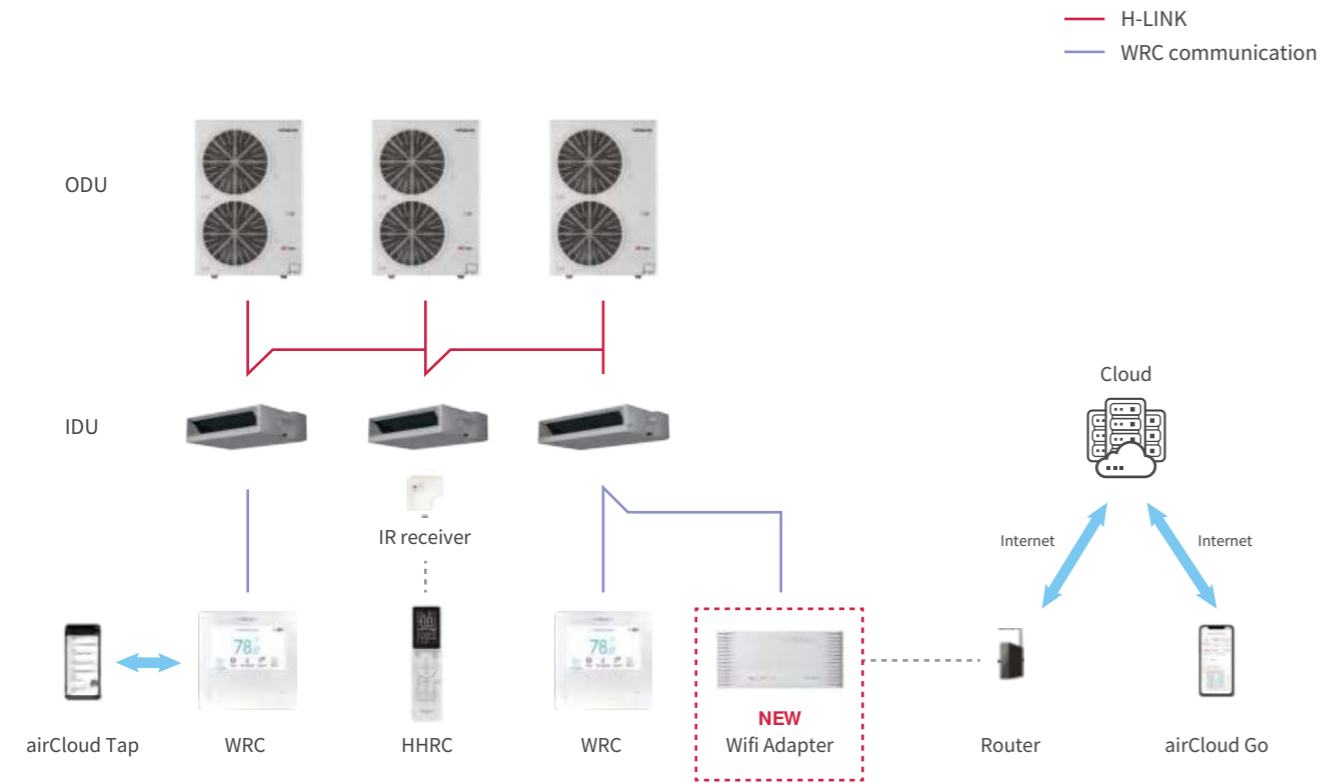

Wifi Adapter

GA-WFG-N

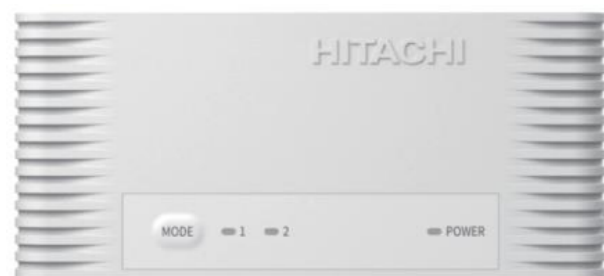

- ABS plastic housing.
- Configuration: AP and WPS.
- Operating temperature: 5°C(41°F) to 35°C(95°F).
- Operating humidity: between 35% and 90%.
- Index protection rating IP30.
- Pollution category: Class 2.
- Dimensions (l × w × h): 105 × 46 × 20 mm.
- Wireless LAN standard: IEEE 802.11b/g/n.
- Security: WPA/WPA2.
- Frequency used and maximum power used: 2.4000 GHz - 2.4835 GHz/erp < 100 mW.
- Power supply: 15V 110mA DC
- Integrated antenna.

H-LINK

Enjoy more freedom

What is H-LINK?

H-LINK is Hitachi Cooling & Heating's unique communication system for centralized control of VRF (Variable Refrigerant Flow) systems. Now, the airCore700, a large single split system, can connect directly to a Hitachi VRF system, enabling centralized controls.

H-LINK simplifies commissioning and service maintenance for installers and service engineers. It also offers remarkable versatility to building owners and occupants by enabling various central control options, resulting in improved system management.

Our advanced communication system streamlines the connection of control wiring between indoor and outdoor units, while also empowering a central control system to manage indoor/outdoor units across multiple refrigerant systems.

Examples

- Educational institutions such as primary schools where installation work cannot be performed on weekdays.
- Hotels where it is preferable to complete installation work during late evenings.
- Rehabilitation facilities or hospitals where it is necessary to minimize the burden on users.

3x
more
benefits!

1
Flexible wiring routes:
no restrictions & time-saving at installation.

2
Can connect with various types of Hitachi air conditioning products, including VRF mini splits and airCore700, for centralized controls.

3
No adapter is needed!
Simple connection to terminal blocks for centralized controls.

Centralized Controls: Flexible Wiring Route!

- Multiple refrigerant systems located in one area.
• Central monitoring room in separate area.

H-LINK SOLUTION

- Wire the central station to the closest indoor unit.
- Wiring distance is reduced substantially.
- Single split system (airCore700) could integrate with VRF system and connect to centralized controls seamlessly without an adapter.

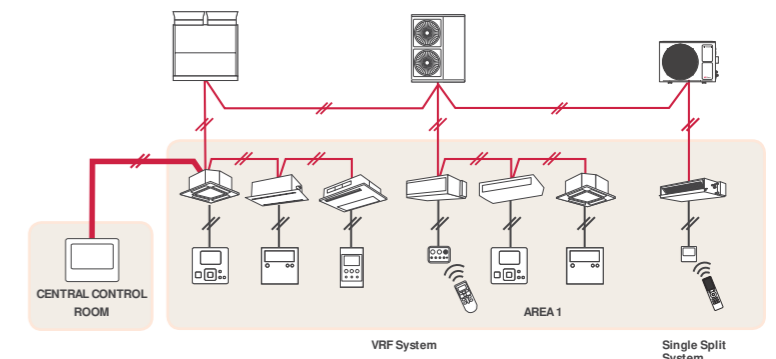

- One single split system is located in another separate area.

H-LINK SOLUTION

- Connect the farthest refrigerant system directly to central station either to outdoor units or indoor units.
- The central station can make the central link between the different refrigerant systems.

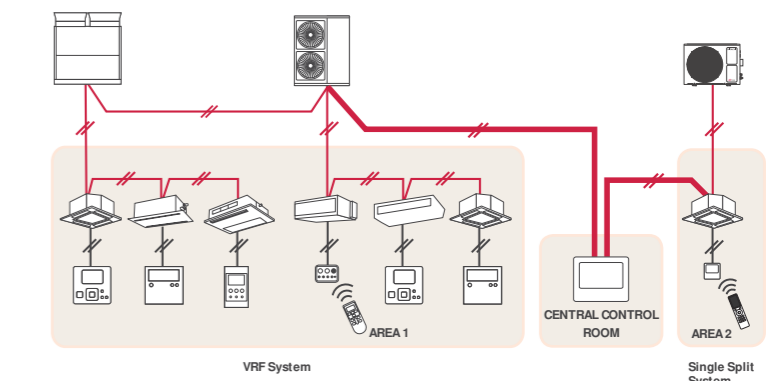

Specifications

DUCTED

IDU		PPIM-B09UFA1DQ	PPIM-B12UFA1DQ	PPIM-B18UFA1DQ	PPIM-B24UFA1DQ	PPIM-B30UFA1DQ	PPIM-B36UFA1DQ	PPIM-B48UFA1DQ	
ODU		PAS-09BUFASDQ1	PAS-12BUFASDQ1	PAS-18BUFASDQ1	PAS-24BUFASDQ1	PAS-30BUFASDQ1	PAS-36BUFASDQ1	PAS-48BUFASDQ1	
Power supply	V/Ph/Hz	208/230,60	208/230,60	208/230,60	208/230,60	208/230,60	208/230,60	208/230,60	
Max. power input	W	1400	1400	3120	3680	5560	6430	6690	
Max. current input	A	7.7	7.7	13.5	16.0	24.2	27.9	27.9	
Cooling	Rated Capacity	Btu/h	9000	12000	18000	22000	30000	43500	
	Capacity Range[Min~Max]	Btu/h	3000-12000	3200-13800	6100-20000	9900-26300	13000-35300	13700-41600	15400-50900
	Power Input	W	690	960	1380	1730	2310	2810	3420
	Current	A	3.1	4.3	6.2	7.7	10.2	12.4	15.2
	EER2	Btu/h/W	13.0	12.5	13.0	12.7	13.0	12.8	12.7
	SEER2	Btu/h/W	20.0	20.5	21.0	20.0	20.0	20.0	21.0
Heating	Rated Capacity	Btu/h	11000	14000	20000	24000	32000	38000	45500
	Capacity Range[Min~Max]	Btu/h	3200-13800	3300-17100	4100-23000	8700-28000	14400-39300	14300-45200	15000-52600
	Power Input	W	870	1110	1500	1750	2400	2780	3510
	Current	A	3.9	5.0	6.7	7.8	10.6	12.3	15.5
	COP2	W/W	3.7	3.7	3.9	4.0	3.9	4.0	3.8
	HSPF2	Btu/h/W	9.6	9.8	9.5	9.6	10.0	9.8	10.0
	Rated Capacity Heating at 17°F	Btu/h	10100	13300	18000	21800	28600	34400	41000
	Maximum Heating Capacity at 5°F	Btu/h	9600	10800	14100	19400	30000	32000	34200
	COP at 5°F [Under Maximum Capacity]	W/W	2.0	2.1	2.1	2.1	2.0	2.0	2.0
	External Static Pressure-Rated	in.WG[Pa]	0.3[75]	0.3[75]	0.3[75]	0.3[75]	0.3[75]	0.3[75]	0.3[75]
External Static Pressure-Range	in.WG[Pa]	0.3-0.6[75-150]	0.3-0.6[75-150]	0.3-0.8[75-200]	0.3-0.8[75-200]	0.3-0.8[75-200]	0.3-0.8[75-200]	0.3-0.8[75-200]	
Fan Motor Output	W	150	150	250	250	375	375	375	
Indoor Unit	Indoor Air Flow [Hi2/Hi1/Hi/Med/Lo/SLo]	CFM m³/h	350/300/290/275/260/245 600/516/492/468/444/420	450/390/350/335/280/245 760/660/600/570/470/420	650/590/550/510/460/420 1100/1008/930/864/790/720	780/740/670/600/560/530 1330/1260/1140/1020/960/900	1060/960/870/770/730/690 1800/1638/1476/1320/1250/1180	1270/1140/1040/950/830/740 2160/1950/1770/1620/1410/1260	1360/1270/1160/1040/950/850 2320/2160/1980/1764/1620/1450
	Sound Pressure Level [Hi2/Hi1/Hi/Med/Lo/SLo]	dB[A]	40/38/37/36/34/33	40/39/38/36/34/33	35/33/31/29/28/26	38/36/33/30/28/27	41/38/36/34/32/30	43/41/39/37/34/32	44/42/40/37/35/33
	Dimension [W×H×D]	inch	[25-19/32(+2-61/64)]×[10-5/8]×[28-11/32]	[25-19/32(+2-61/64)]×[10-5/8]×[28-11/32]	[43-5/16(2-61/64)]×[11-3/16]×[31-1/2]	[43-5/16(2-61/64)]×[11-3/16]×[31-1/2]	[43-5/16(2-61/64)]×[11-3/16]×[31-1/2]	[55-1/8(2-61/64)]×[11-3/16]×[31-1/2]	[55-1/8(2-61/64)]×[11-3/16]×[31-1/2]
		mm	650(+75)×270×720	650(+75)×270×720	1100(+75)×300×800	1100(+75)×300×800	1100(+75)×300×800	1400(+75)×300×800	1400(+75)×300×800
	Net Weight	lbs[kg]	52.9[24.0]	52.9[24.0]	92.6[42.0]	92.6[42.0]	92.6[42.0]	105.8[48.0]	105.8[48.0]
	Drainage water pipe diameter	inch[mm]	1-1/4[Φ32]	1-1/4[Φ32]	1-1/4[Φ32]	1-1/4[Φ32]	1-1/4[Φ32]	1-1/4[Φ32]	1-1/4[Φ32]
Sound Pressure Level	dB[A]	55	55	55	55	55	55	56	
Outdoor Unit	Throttle Type	Electronic Expansion Valve		Electronic Expansion Valve		Electronic Expansion Valve		Electronic Expansion Valve	
	Dimension [W×H×D]	inch	[31-57/64]×[23-1/32]×[11-1/32]	[31-57/64]×[23-1/32]×[11-1/32]	[35-7/16]×[26-3/16]×[12-19/32]	[35-7/16]×[26-3/16]×[12-19/32]	[37-13/32]×[38-31/32]×[12-19/32]	[37-13/32]×[38-31/32]×[12-19/32]	[37-13/32]×[54-21/64]×[12-19/32]
		mm	810×585×280	810×585×280	900×665×320	900×665×320	950×990×320	950×990×320	950×1380×320
	Net Weight	lbs[kg]	77.2[35.0]	77.2[35.0]	97.0[44.0]	101.4[46.0]	194.0[88.0]	194.0[88.0]	250.2[113.5]
Refrigerant type / Quantity	Type	R32		R32		R32		R32	
	Charge	lbs[kg]	1.98[0.9]	1.98[0.9]	2.65[1.2]	3.09[1.4]	5.73[2.6]	5.73[2.6]	7.50[3.4]
Design pressure	H/L	PSIG	602/321	602/321	602/321	602/321	602/321	602/321	
		MPa	4.15/2.21	4.15/2.21	4.15/2.21	4.15/2.21	4.15/2.21	4.15/2.21	
Refrigerant Piping	Liquid side	inch[mm]	[1/4] Φ6.35	[1/4] Φ6.35	[1/4] Φ6.35	[1/4] Φ6.35	[3/8] Φ9.52	[3/8] Φ9.52	
	Gas side	inch[mm]	[1/2] Φ12.7	[1/2] Φ12.7	[1/2] Φ12.7	[1/2] Φ12.7	[5/8] Φ15.88	[5/8] Φ15.88	
	Max. pipe length	ft[m]	164[50]	164[50]	164[50]	164[50]	246[75]	246[75]	
	Max. Height difference	ft[m]	98.4[30]	98.4[30]	98.4[30]	98.4[30]	98.4[30]	98.4[30]	
	Add Refrigerant Amount	oz/ft[g/m]	0.194[18]	0.194[18]	0.194[18]	0.194[18]	0.376[35]	0.376[35]	
	Chargeless	ft[m]	98.4[30]	98.4[30]	98.4[30]	98.4[30]	98.4[30]	98.4[30]	
Guaranteed Temperature Operation Range	Cooling	°F[°C]	0-115[-18~46]	0-115[-18~46]	0-115[-18~46]	0-115[-18~46]	0-115[-18~46]	0-115[-18~46]	
	Heating	°F[°C]	-13-75[-25~24]	-13-75[-25~24]	-13-75[-25~24]	-13-75[-25~24]	-13-75[-25~24]	-13-75[-25~24]	

Specifications

DUCTED (HeatForce series)

IDU ODU		PPIM-B12UFA1DQ PAS-12BLFASDQ1	PPIM-B18UFA1DQ PAS-18BLFASDQ1	PPIM-B24UFA1DQ PAS-24BLFASDQ1	PPIM-B30UFA1DQ PAS-30BLFASDQ1	PPIM-B36UFA1DQ PAS-36BLFASDQ1	
Power supply	V/Ph/Hz	208/230,60	208/230,60	208/230,60	208/230,60	208/230,60	
Max. power input	W	3120	4000	5560	6430	6690	
Max. current input	A	13.5	16.0	24.2	27.9	29.1	
Cooling	Rated Capacity	Btu/h	12000	18000	24000	30000	36000
	Capacity Range[Min~Max]	Btu/h	4500-15500	6500-23000	10000-30000	13000-36000	14000-43000
	Power Input	W	860	1410	1800	2340	2700
	Current	A	3.8	6.3	7.9	10.3	11.9
	EER2	Btu/h/W	13.9	12.7	13.3	12.8	13.3
	SEER2	Btu/h/W	20.5	20.2	18.5	18.7	21.5
Heating	Rated Capacity at 47°F	Btu/h	14000	20000	26000	32000	38000
	Capacity Range[Min~Max]	Btu/h	4800-20000	6600-26000	9500-35000	14000-40000	14500-46000
	Power Input	W	1025	1460	1810	2340	2650
	Current	A	4.5	6.5	8.0	10.3	11.7
	COP2	W/W	4.0	4.0	4.2	4.0	4.2
	HSPF2	Btu/h/W	10.0	9.8	9.8	10.1	10.7
	Rated Capacity Heating at 17°F	Btu/h	12600	18000	21600	28600	34200
	Maximum Heating Capacity at 5°F	Btu/h	10300	17000	22000	23000	28500
COP at 5°F [Under Maximum Capacity]	W/W	2.1	2.1	2.1	2.1	2.1	
Indoor Unit	External Static Pressure-Rated	in.WG[Pa]	0.3[75]	0.3[75]	0.3[75]	0.3[75]	0.3[75]
	External Static Pressure-Range	in.WG[Pa]	0.3-0.6[75-150]	0.3-0.8[75-200]	0.3-0.8[75-200]	0.3-0.8[75-200]	0.3-0.8[75-200]
	Fan Motor Output	W	150	250	250	375	375
	Indoor Air Flow [Hi2/Hi1/Hi/Med/Lo/SLo]	CFM m³/h	450/390/350/335/280/245 760/660/600/570/470/420	650/590/550/510/460/420 1100/1008/930/864/790/720	780/740/670/600/560/530 1330/1260/1140/1020/960/900	1060/960/870/770/730/690 1800/1638/1476/1320/1250/1180	1270/1140/1040/950/830/740 2160/1950/1770/1620/1410/1260
	Sound Pressure Level [Hi2/Hi1/Hi/Med/Lo/SLo]	dB[A]	40/39/38/36/34/33	35/33/31/29/28/26	38/36/33/30/28/27	41/38/36/34/32/30	43/41/39/37/34/32
	Dimension [W×H×D]	inch mm	[25-19/32(+2-61/64)]×[10-5/8]×[28-11/32] 650(+75)×270×720	[43-5/16(2-61/64)]×[11-3/16]×[31-1/2] 1100(+75)×300×800	[43-5/16(2-61/64)]×[11-3/16]×[31-1/2] 1100(+75)×300×800	[43-5/16(2-61/64)]×[11-3/16]×[31-1/2] 1100(+75)×300×800	[55-1/8(2-61/64)]×[11-3/16]×[31-1/2] 1400(+75)×300×800
	Net Weight	lbs[kg]	52.9[24]	93[42]	93[42]	93[42]	106[48]
	Drainage water pipe diameter	inch[mm]	1-1/4[Φ32]	1-1/4[Φ32]	1-1/4[Φ32]	1-1/4[Φ32]	1-1/4[Φ32]
	Sound Pressure Level	dB[A]	55	55	55	55	56
	Outdoor Unit	Throttle Type	Electronic Expansion Valve		Electronic Expansion Valve		Electronic Expansion Valve
Dimension [W×H×D]		inch mm	[35-7/16]×[26-3/16]×[12-19/32] 900×665×320	[35-7/16]×[26-3/16]×[12-19/32] 900×665×320	[37-13/32]×[38-31/32]×[12-19/32] 950×990×320	[37-13/32]×[38-31/32]×[12-19/32] 950×990×320	[37-13/32]×[54-21/64]×[12-19/32] 950×1380×320
Net Weight		lbs[kg]	97.0[44]	101.0[46]	194.0[88]	194.0[88]	250.0[113.5]
Refrigerant type / Quantity		Type Charge	R32 2.65[1.2]	R32 3.09[1.4]	R32 5.73[2.6]	R32 5.73[2.6]	R32 7.50[3.4]
Design pressure	H/L	PSIG MPa	602/321 4.15/2.21	602/321 4.15/2.21	602/321 4.15/2.21	602/321 4.15/2.21	602/321 4.15/2.21
	Refrigerant Piping	Liquid side Gas side Max. pipe length Max. Height difference Add Refrigerant Amount Chargeless	inch[mm] inch[mm] ft[m] ft[m] oz/ft[g/m] ft[m]	[1/4] Φ6.35 [1/2] Φ12.7 164[50] 98.4[30] 0.194[18] 98.4[30]	[1/4] Φ6.35 [1/2] Φ12.7 164[50] 98.4[30] 0.194[18] 98.4[30]	[3/8] Φ9.53 [5/8] Φ15.88 246[75] 98.4[30] 0.376[35] 98.4[30]	[3/8] Φ9.52 [5/8] Φ15.88 246[75] 98.4[30] 0.376[35] 98.4[30]
Guaranteed Temperature Operation Range	Cooling	°F[°C]	0-115[-18~46]	0-115[-18~46]	0-115[-18~46]	0-115[-18~46]	0-115[-18~46]
	Heating	°F[°C]	-13-75[-25~24]	-13-75[-25~24]	-13-75[-25~24]	-13-75[-25~24]	-13-75[-25~24]

Specifications

CASSETTE

IDU		PCIM-B09UFA1DQ	PCIM-B12UFA1DQ	PCI-B18UFA1DQ	PCI-B24UFA1DQ	PCI-B30UFA1DQ	PCI-B36UFA1DQ	PCI-B48UFA1DQ	
ODU		PAS-09BUFASDQ1	PAS-12BUFASDQ1	PAS-18BUFASDQ1	PAS-24BUFASDQ1	PAS-30BUFASDQ1	PAS-36BUFASDQ1	PAS-48BUFASDQ1	
Power supply	V/Ph/Hz	208/230,60	208/230,60	208/230,60	208/230,60	208/230,60	208/230,60	208/230,60	
Max. power input	W	1400	1400	3120	3680	5560	6430	6690	
Max. current input	A	7.7	7.7	13.5	16.0	24.2	27.9	29.1	
Cooling	Rated Capacity	Btu/h	9000	12000	18000	22000	30000	45000	
	Capacity Range[Min~Max]	Btu/h	3100-12300	3200-14200	6570-21100	10620-27000	14300-37500	15000-43000	16050-51700
	Power Input	W	600	850	1200	1690	2140	2770	3460
	Current	A	2.7	3.8	5.3	7.5	9.5	12.3	15.4
	EER2	Btu/h/W	15.0	14.0	15.0	13.0	14.0	13.0	13.0
	SEER2	Btu/h/W	23.5	23.5	27.0	24.0	21.0	21.0	22.5
Heating	Rated Capacity	Btu/h	11000	14000	20000	24000	32000	38000	47000
	Capacity Range[Min~Max]	Btu/h	3300-14200	3400-17400	4900-24500	9460-29750	16300-41200	16330-48250	17080-54170
	Power Input	W	805	950	1330	1600	2130	2720	3720
	Current	A	3.6	4.2	5.9	7.1	9.4	12.1	16.5
	COP2	W/W	4.0	4.3	4.4	4.4	4.4	4.1	3.7
	HSPF2	Btu/h/W	11.0	10.0	11.0	10.0	10.0	10.0	10.0
	Rated Capacity Heating at 17°F	Btu/h	10500	12600	17000	20000	28000	34000	39000
	Maximum Heating Capacity at 5°F	Btu/h	10000	10800	15000	19000	24000	30000	34000
	COP at 5°F [Under Maximum Capacity]	W/W	2.2	2.2	2.6	2.5	2.4	2.4	2.2
	External Static Pressure-Rated	in.WG[Pa]	0	0	0	0	0	0	0
External Static Pressure-Range	in.WG[Pa]	0	0	0	0	0	0	0	
Fan Motor Output	W	57	57	60	127	127	127	127	
Indoor Unit	Indoor Air Flow [Hi2/Hi1/Hi/Med/Lo/SLo]	CFM m³/h	320/295/275/250 540/500/470/420	425/390/305/250 720/660/520/420	650/600/570/530 1100/1030/970/900	780/740/700/630 1330/1260/1190/1080	1060/940/820/740 1800/1600/1400/1260	1170/1060/950/740 1990/1800/1620/1260	1170/1060/950/740 1990/1800/1620/1260
	Sound Pressure Level [Hi2/Hi1/Hi/Med/Lo/SLo]	dB[A]	39/37/36/33	46/44/38/33	39/37/36/34	41/39/38/35	49/47/43/40	49/48/47/40	49/48/47/40
	Dimension [W×H×D]	inch	[22-7/16]×[8-15/32]×[22-7/16]	[22-7/16]×[8-15/32]×[22-7/16]	[33-5/64]×[9-3/8]×[33-5/64]	[33-5/64]×[11-11/32]×[33-5/64]	[33-5/64]×[11-11/32]×[33-5/64]	[33-5/64]×[11-11/32]×[33-5/64]	[33-5/64]×[11-11/32]×[33-5/64]
		mm	570×215×570	570×215×570	840×238×840	840×288×840	840×288×840	840×288×840	840×288×840
	Net Weight	lbs[kg]	34[15.4]	34[15.4]	50.7[23]	59.5[27]	59.5[27]	59.5[27]	59.5[27]
	Drainage water pipe diameter	inch[mm]	1-3/16[Φ30]	1-3/16[Φ30]	1-3/16[Φ30]	1-3/16[Φ30]	1-3/16[Φ30]	1-3/16[Φ30]	1-3/16[Φ30]
Sound Pressure Level	dB[A]	55	55	55	55	55	55	55	
Outdoor Unit	Throttle Type	Electronic Expansion Valve		Electronic Expansion Valve	Electronic Expansion Valve	Electronic Expansion Valve	Electronic Expansion Valve	Electronic Expansion Valve	
	Dimension [W×H×D]	inch	[31-57/64]×[23-1/32]×[11-1/32]	[31-57/64]×[23-1/32]×[11-1/32]	[35-7/16]×[26-3/16]×[12-19/32]	[35-7/16]×[26-3/16]×[12-19/32]	[37-13/32]×[38-31/32]×[12-19/32]	[37-13/32]×[38-31/32]×[12-19/32]	[37-13/32]×[54-21/64]×[12-19/32]
		mm	810×585×280	810×585×280	900×665×320	900×665×320	950×990×320	950×990×320	950×1380×320
	Net Weight	lbs[kg]	77.2[35]	77.2[35]	97.4[44.2]	102.3[46.4]	194.2[88.1]	194.2[88.1]	251.1[113.9]
Refrigerant type / Quantity	Type	R32		R32	R32	R32	R32	R32	
	Charge	lbs[kg]	1.98[0.9]	1.98[0.9]	2.65[1.2]	3.09[1.4]	5.73[2.6]	5.73[2.6]	7.50[3.4]
Design pressure	H/L	PSIG		602/321	602/321	602/321	602/321	602/321	
		MPa	4.15/2.21	4.15/2.21	4.15/2.21	4.15/2.21	4.15/2.21	4.15/2.21	
Refrigerant Piping	Liquid side	inch[mm]	[1/4] Φ6.35	[1/4] Φ6.35	[1/4] Φ6.35	[3/8] Φ9.52	[3/8] Φ9.52	[3/8] Φ9.52	
	Gas side	inch[mm]	[1/2] Φ12.7	[1/2] Φ12.7	[1/2] Φ12.7	[5/8] Φ15.88	[5/8] Φ15.88	[5/8] Φ15.88	
	Max. pipe length	ft[m]	164[50]	164[50]	164[50]	164[50]	246[75]	246[75]	
	Max. Height difference	ft[m]	98.4[30]	98.4[30]	98.4[30]	98.4[30]	98.4[30]	98.4[30]	
	Add Refrigerant Amount	oz/ftg/m	0.194[18]	0.194[18]	0.194[18]	0.194[18]	0.376[35]	0.376[35]	
	Chargeless	ft[m]	98.4[30]	98.4[30]	98.4[30]	98.4[30]	98.4[30]	98.4[30]	
Guaranteed Temperature Operation Range	Cooling	°F[°C]	0-115[-18~46]	0-115[-18~46]	0-115[-18~46]	0-115[-18~46]	0-115[-18~46]	0-115[-18~46]	
	Heating	°F[°C]	-13-75[-25~24]	-13-75[-25~24]	-13-75[-25~24]	-13-75[-25~24]	-13-75[-25~24]	-13-75[-25~24]	

Specifications

CASSETTE (HeatForce series)

IDU		PCIM-B12UFA1DQ	PCI-B18UFA1DQ	PCI-B24UFA1DQ	PCI-B30UFA1DQ	PCI-B36UFA1DQ	
ODU		PAS-12BLFASDQ1	PAS-18BLFASDQ1	PAS-24BLFASDQ1	PAS-30BLFASDQ1	PAS-36BLFASDQ1	
Power supply	V/Ph/Hz	208/230,60	208/230,60	208/230,60	208/230,60	208/230,60	
Max. power input	W	3120	3680	5560	6430	6690	
Max. current input	A	13.5	16.0	24.2	27.9	29.1	
Cooling	Rated Capacity	Btu/h	12000	18000	24000	30000	36000
	Capacity Range[Min~Max]	Btu/h	4600-16000	6600-23000	10000-30000	13500-38000	14000-45000
	Power Input	W	725	1220	1700	2150	2400
	Current	A	3.2	5.4	7.5	9.5	10.6
	EER2	Btu/h/W	16.5	14.7	14.0	13.9	15.0
	SEER2	Btu/h/W	24.9	24.1	19.5	20.3	23.6
Heating	Rated Capacity at 47°F	Btu/h	14000	20000	26000	32000	38000
	Capacity Range[Min~Max]	Btu/h	4800-20000	6800-26000	9600-35000	14300-42000	15000-48000
	Power Input	W	890	1270	1810	2080	2530
	Current	A	3.9	5.6	8.0	9.2	11.2
	COP2	W/W	4.6	4.6	4.2	4.5	4.4
	HSPF2	Btu/h/W	11.3	11.5	10.8	11.2	10.9
	Rated Capacity Heating at 17°F	Btu/h	12600	18000	21600	28600	34200
	Maximum Heating Capacity at 5°F	Btu/h	10400	18000	22200	24000	30100
COP at 5°F [Under Maximum Capacity]	W/W	2.3	2.2	2.3	2.3	2.1	
Indoor Unit	External Static Pressure-Rated	in.WG[Pa]	0	0	0	0	0
	External Static Pressure-Range	in.WG[Pa]	0	0	0	0	0
	Fan Motor Output	W	57	60	127	127	127
	Indoor Air Flow [Hi2/Hi1/Hi/Med/Lo/SLo]	CFM m³/h	425/390/305/250 720/660/520/420	650/600/570/530 1100/1030/970/900	780/740/700/630 1330/1260/1190/1080	1060/940/820/740 1800/1600/1400/1260	1170/1060/950/740 1990/1800/1620/1260
	Sound Pressure Level [Hi2/Hi1/Hi/Med/Lo/SLo]	dB[A]	46/44/38/33	39/37/36/34	41/39/38/35	49/47/43/40	49/48/47/40
	Dimension [W×H×D]	inch mm	[22-7/16]×[8-15/32]×[22-7/16] 570×215×570	[33-5/64]×[9-3/8]×[33-5/64] 840×238×840	[33-5/64]×[11-11/32]×[33-5/64] 840×288×840	[33-5/64]×[11-11/32]×[33-5/64] 840×288×840	[33-5/64]×[11-11/32]×[33-5/64] 840×288×840
	Net Weight	lbs[kg]	34[15.4]	50.7[23]	59.5[27]	59.5[27]	59.5[27]
	Drainage water pipe diameter	inch[mm]	1-3/16[Φ30]	1-3/16[Φ30]	1-3/16[Φ30]	1-3/16[Φ30]	1-3/16[Φ30]
	Sound Pressure Level	dB[A]	55	55	55	55	56
	Outdoor Unit	Throttle Type		Electronic Expansion Valve	Electronic Expansion Valve	Electronic Expansion Valve	Electronic Expansion Valve
Dimension [W×H×D]		inch mm	[35-7/16]×[26-3/16]×[12-19/32] 900×665×320	[35-7/16]×[26-3/16]×[12-19/32] 900×665×320	[37-13/32]×[38-31/32]×[12-19/32] 950×990×320	[37-13/32]×[38-31/32]×[12-19/32] 950×990×320	[37-13/32]×[38-31/32]×[12-19/32] 950×990×320
Net Weight		lbs[kg]	97.0[44]	101.0[46]	194.0[88]	194.2[88.1]	250.0[113.5]
Refrigerant type / Quantity		Type Charge	R32 lbs[kg]	R32 3.09[1.4]	R32 5.73[2.6]	R32 5.73[2.6]	R32 7.50[3.4]
Design pressure	H/L	PSIG MPa	602/321 4.15/2.21	602/321 4.15/2.21	602/321 4.15/2.21	602/321 4.15/2.21	
	Liquid side	inch[mm]	[1/4] Φ6.35	[1/4] Φ6.35	[3/8] Φ9.52	[3/8] Φ9.52	
Refrigerant Piping	Gas side	inch[mm]	[1/2] Φ12.7	[1/2] Φ12.7	[5/8] Φ15.88	[5/8] Φ15.88	
	Max. pipe length	ft[m]	164[50]	164[50]	246[75]	246[75]	
	Max. Height difference	ft[m]	98.4[30]	98.4[30]	98.4[30]	98.4[30]	
	Add Refrigerant Amount	oz/ft[g/m]	0.194[18]	0.194[18]	0.376[35]	0.376[35]	
	Chargeless	ft[m]	98.4[30]	98.4[30]	98.4[30]	98.4[30]	
Guaranteed Temperature Operation Range	Cooling	°F[°C]	0-115[-18~46]	0-115[-18~46]	0-115[-18~46]	0-115[-18~46]	
	Heating	°F[°C]	-13-75[-25~24]	-13-75[-25~24]	-13-75[-25~24]	-13-75[-25~24]	

Specifications

CEILING SUSPENDED

IDU		PPFC-B09UFA1DQ	PPFC-B12UFA1DQ	PPFC-B18UFA1DQ	PPFC-B24UFA1DQ	PPFC-B30UFA1DQ	PPFC-B36UFA1DQ	PPFC-B48UFA1DQ	
ODU		PAS-09BUFASDQ1	PAS-12BUFASDQ1	PAS-18BUFASDQ1	PAS-24BUFASDQ1	PAS-30BUFASDQ1	PAS-36BUFASDQ1	PAS-48BUFASDQ1	
Power supply	V/Ph/Hz	208/230,60	208/230,60	208/230,60	208/230,60	208/230,60	208/230,60	208/230,60	
Max. power input	W	14000	14000	3120	3680	5560	6430	6690	
Max. current input	A	7.7	7.7	13.5	16.0	24.2	27.9	29.1	
Cooling	Rated Capacity	Btu/h	9000	12000	18000	22000	30000	36000	42000
	Capacity Range[Min~Max]	Btu/h	3000-11800	3200-13800	5900-20000	9900-26000	13100-35830	13200-40800	14800-48750
	Power Input	W	600	890	1380	1690	2500	3000	3500
	Current	A	2.7	3.9	6.1	7.5	11.1	13.3	15.5
	EER2	Btu/h/W	15.0	13.5	13.0	13.0	12.0	12.0	12.0
	SEER2	Btu/h/W	23.0	22.0	23.0	21.0	19.6	19.4	20.5
Heating	Rated Capacity	Btu/h	11000	14000	20000	24000	32000	38000	44000
	Capacity Range[Min~Max]	Btu/h	3200-13300	3300-16700	4200-24100	9200-29600	15100-42000	15400-46900	15700-51850
	Power Input	W	765	1025	1500	1800	2290	2850	3580
	Current	A	3.4	4.5	6.6	8.0	10.2	12.6	15.9
	COP2	W/W	4.2	4.0	3.9	3.9	4.1	3.9	3.6
	HSPF2	Btu/h/W	9.5	9.8	10.0	10.0	10.0	10.0	9.5
	Rated Capacity Heating at 17°F	Btu/h	9900	12800	18000	20000	28000	33000	40000
	Maximum Heating Capacity at 5°F	Btu/h	9900	11100	14500	19000	26000	27000	32000
COP at 5°F [Under Maximum Capacity]	W/W	2.2	2.2	2.4	2.5	2.5	2.4	2.2	
Indoor Unit	External Static Pressure-Rated	in.WG[Pa]	0	0	0	0	0	0	0
	External Static Pressure-Range	in.WG[Pa]	0	0	0	0	0	0	0
	Fan Motor Output	W	100	100	100	181	181	181	181
	Indoor Air Flow [Hi2/Hi1/Hi/Med/L0/SL0]	CFM m³/h	320/295/275/250 540/500/470/420	450/390/320/275 760/660/540/470	540/520/460/400 918/880/780/680	780/740/680/560 1330/1260/1150/960	1010/940/820/740 1720/1600/1400/1260	1170/1010/890/780 1990/1720/1510/1330	1170/1010/890/780 1990/1720/1510/1330
	Sound Pressure Level [Hi2/Hi1/Hi/Med/L0/SL0]	dB[A]	37/35/33/30	45/41/37/33	47/46/43/39	47/45/43/40	50/47/44/42	53/50/47/44	53/50/47/44
	Dimension [W×H×D]	inch mm	[38-31/32]×[9-1/16]×[26-49/64] 990×230×680	[38-31/32]×[9-1/16]×[26-49/64] 990×230×680	[38-31/32]×[9-1/16]×[26-49/64] 990×230×680	[62-13/64]×[9-1/16]×[26-49/64] 1580×230×680	[62-13/64]×[9-1/16]×[26-49/64] 1580×230×680	[62-13/64]×[9-1/16]×[26-49/64] 1580×230×680	[62-13/64]×[9-1/16]×[26-49/64] 1580×230×680
	Net Weight	lbs[kg]	70.5[32]	70.5[32]	70.5[32]	1580×230×680	105.8[48]	105.8[48]	105.8[48]
	Drainage water pipe diameter	inch[mm]	1-3/16[Φ30]	1-3/16[Φ30]	1-3/16[Φ30]	1-3/16[Φ30]	1-3/16[Φ30]	1-3/16[Φ30]	1-3/16[Φ30]
	Sound Pressure Level	dB[A]	55	55	55	55	55	55	56
	Outdoor Unit	Throttle Type		Electronic Expansion Value	Electronic Expansion Value	Electronic Expansion Value	Electronic Expansion Value	Electronic Expansion Value	Electronic Expansion Value
Dimension [W×H×D]		inch mm	[31-57/64]×[23-1/32]×[11-1/32] 810×585×280	[31-57/64]×[23-1/32]×[11-1/32] 810×585×280	[35-7/16]×[26-3/16]×[12-19/32] 900×665×320	[35-7/16]×[26-3/16]×[12-19/32] 900×665×320	[37-13/32]×[38-31/32]×[12-19/32] 950×990×320	[37-13/32]×[38-31/32]×[12-19/32] 950×990×320	[37-13/32]×[54-21/64]×[12-19/32] 950×1380×320
Net Weight		lbs[kg]	77.2[35]	77.2[35]	97.4[44.2]	101.4[46.0]	194.2[88.1]	194.2[88.1]	251.1[113.9]
Refrigerant type / Quantity		Type Charge	R32 1.98[0.9]	R32 1.98[0.9]	R32 2.65[1.2]	R32 3.09[1.4]	R32 5.73[2.6]	R32 5.73[2.6]	R32 7.50[3.4]
Design pressure	H/L	PSIG MPa	602/321 4.15/2.21	602/321 4.15/2.21	602/321 4.15/2.21	602/321 4.15/2.21	602/321 4.15/2.21	602/321 4.15/2.21	602/321 4.15/2.21
	Refrigerant Piping	Liquid side Gas side Max. pipe length Max. Height difference Add Refrigerant Amount Chargeless	inch[mm] inch[mm] ft[m] ft[m] oz/ft[g/m] ft[m]	[1/4] Φ6.35 [1/2] Φ12.7 164[50] 98.4[30] 0.194[18] 98.4[30]	[1/4] Φ6.35 [1/2] Φ12.7 164[50] 98.4[30] 0.194[18] 98.4[30]	[1/4] Φ6.35 [1/2] Φ12.7 164[50] 98.4[30] 0.194[18] 98.4[30]	[1/4] Φ6.35 [1/2] Φ12.7 164[50] 98.4[30] 0.194[18] 98.4[30]	[3/8] Φ9.52 [5/8] Φ15.88 246[75] 98.4[30] 0.376[35] 98.4[30]	[3/8] Φ9.52 [5/8] Φ15.88 246[75] 98.4[30] 0.376[35] 98.4[30]
Guaranteed Temperature Operation Range	Cooling	°F[°C]	0-115[-18~46]	0-115[-18~46]	0-115[-18~46]	0-115[-18~46]	0-115[-18~46]	0-115[-18~46]	
	Heating	°F[°C]	-13-75[-25~24]	-13-75[-25~24]	-13-75[-25~24]	-13-75[-25~24]	-13-75[-25~24]	-13-75[-25~24]	

Specifications

AIR HANDLERS

IDU		JPE18B3XB2HS1A	JPE24B3XC2HS1A	JPE30B3XD2HS1A	JPE36B3XD2HS1A	JPE48C3XG2HS1A	
ODU		PAS-18BUFASDQ1	PAS-24BUFASDQ1	PAS-30BUFASDQ1	PAS-36BUFASDQ1	PAS-48BUFASDQ1	
Power supply	V/Ph/Hz	208/230,60	208/230,60	208/230,60	208/230,60	208/230,60	
Max. power input	W	-	-	-	-	-	
Max. current input	A	-	-	-	-	-	
Cooling	Rated Capacity	Btu/h	18000	22000	28000	33000	48000
	Capacity Range[Min~Max]	Btu/h	6000~21000	10000~26000	13000~36000	13000~41000	15000~52000
	Power Input	W	1540	1880	2400	3300	4110
	Current	A	-	-	-	-	-
	EER2	Btu/h/W	11.7	11.7	11.7	10.0	11.7
	SEER2	Btu/h/W	18.0	18.0	18.0	18.0	18.0
Heating	Rated Capacity	Btu/h	19000	24000	33000	38000	48000
	Capacity Range[Min~Max]	Btu/h	4100~23000	8700~28000	14400~39300	14300~45200	15000~52600
	Power Input	W	1465	2010	2735	2930	3910
	Current	A	-	-	-	-	-
	COP2	W/W	3.80	3.50	3.43	3.80	3.60
	HSPF2	Btu/h/W	8.5	8.5	8.5	8.5	8.5
	Rated Capacity Heating at 17°F	Btu/h	17000	19500	28000	28000	40000
	Maximum Heating Capacity at 5°F	Btu/h	14800	18100	32400	32400	36400
	COP at 5°F [Under Maximum Capacity]	W/W	2.2	1.9	2.0	2.0	2.0
	External Static Pressure-Rated	in.WG[Pa]	-	-	-	-	-
External Static Pressure-Range	in.WG[Pa]	-	-	-	-	-	
Fan Motor Output	W	248.5	248.5	373.0	373.0	559.0	
Indoor Unit	Indoor Air Flow [Hi2/Hi/Med/Lo]	CFM	675/600/425	775/525/425	1200/800/700	1200/800/700	1575/1175/925
		m ³ /h	-	-	-	-	-
	Sound Pressure Level [Hi2/Hi/Med/Lo]	dB[A]	-	-	-	-	-
	Dimension [W×H×D]	inch	[17-1/2]×[45-5/8]×[20-1/2]	[17-1/2]×[48-3/8]×[20-1/2]	[17-1/2]×[48-3/8]×[20-1/2]	[17-1/2]×[48-3/8]×[20-1/2]	[21]×[60]×[20-1/2]
		mm	-	-	-	-	-
	Net Weight	lbs[kg]	93	99	100	100	129
Drainage water pipe diameter	inch[mm]	-	-	-	-	-	
Sound Pressure Level	dB[A]	55	55	58	58	59	
Outdoor Unit	Throttle Type	Electronic Expansion Value		Electronic Expansion Value		Electronic Expansion Value	
	Dimension [W×H×D]	inch	[35-7/16]×[26-3/16]×[12-19/32]	[35-7/16]×[26-3/16]×[12-19/32]	[37-13/32]×[38-31/32]×[12-19/32]	[37-13/32]×[38-31/32]×[12-19/32]	[37-13/32]×[54-21/64]×[12-19/32]
		mm	900×665×320	900×665×320	950×990×320	950×990×320	950×990×320
	Net Weight	lbs[kg]	97.0[44.0]	101.4[46.0]	194.0[88.0]	194.0[88.0]	250.2[113.5]
Refrigerant type / Quantity	Type	R32		R32		R32	
	Charge	lbs[kg]	1.98[0.9]	1.98[0.9]	5.73[2.6]	5.73[2.6]	7.50[3.4]
Design pressure	H/L	PSIG	602/321	602/321	602/321	602/321	602/321
		MPa	4.15/2.21	4.15/2.21	4.15/2.21	4.15/2.21	4.15/2.21
Refrigerant Piping	Liquid side	inch[mm]	[1/4] Φ6.35	[1/4] Φ6.35	3/8[Φ9.53]	3/8[Φ9.53]	3/8[Φ9.53]
	Gas side	inch[mm]	[1/2] Φ12.7	[1/2] Φ12.7	5/8[Φ15.88]	5/8[Φ15.88]	5/8[Φ15.88]
	Max. pipe length	ft[m]	164[50]	164[50]	246[75]	246[75]	246[75]
	Max. Height difference	ft[m]	98.4[30]	98.4[30]	98.4[30]	98.4[30]	98.4[30]
	Add Refrigerant Amount	oz/ftg[m]	0.194[18]	0.194[18]	0.376[35]	0.376[35]	0.376[35]
	Chargeless	ft[m]	98.4[30]	98.4[30]	98.4[30]	98.4[30]	98.4[30]
Guaranteed Temperature Operation Range	Cooling	°F[°C]	0-115[-18~46]	0-115[-18~46]	0-115[-18~46]	0-115[-18~46]	0-115[-18~46]
	Heating	°F[°C]	-13-75[-25~24]	-13-75[-25~24]	-13-75[-25~24]	-13-75[-25~24]	-13-75[-25~24]

Specifications

HIGH WALL

IDU		PPK-B09UFA1DQ	PPK-B12UFA1DQ	PPK-B18UFA1DQ	PPK-B24UFA1DQ	PPK-B30UFA1DQ	
ODU		PAS-09BUFASDQ1	PAS-12BUFASDQ1	PAS-18BUFASDQ1	PAS-24BUFASDQ1	PAS-30BUFASDQ1	
Power supply	V/Ph/Hz	208/230,60	208/230,60	208/230,60	208/230,60	208/230,60	
Max. power input	W	1400	1400	3120	3680	5560	
Max. current input	A	7.7	7.7	13.5	16.0	24.2	
Cooling	Rated Capacity	Btu/h	9000	12000	18000	22000	30000
	Capacity Range[Min~Max]	Btu/h	3000-11800	3200-13800	5900-20000	9900-26000	13100-35830
	Power Input	W	600	800	1290	1690	2140
	Current	A	2.7	3.6	5.7	7.5	9.5
	EER2	Btu/h/W	15.0	15.0	14.0	13.0	14.0
	SEER2	Btu/h/W	22.0	23.0	23.0	21.5	21.8
Heating	Rated Capacity	Btu/h	11000	14000	20000	24000	32000
	Capacity Range[Min~Max]	Btu/h	3200-13300	3300-16700	4200-24100	9200-29600	15100-42000
	Power Input	W	850	1050	1585	1850	2350
	Current	A	3.8	4.7	7.0	8.2	10.4
	COP2	W/W	3.8	3.9	3.7	3.8	4.0
	HSPF2	Btu/h/W	10.0	9.5	10.0	9.1	10.0
	Rated Capacity Heating at 17°F	Btu/h	8000	9800	14000	16800	22400
	Maximum Heating Capacity at 5°F	Btu/h	7700	9800	14000	16800	22400
COP at 5°F [Under Maximum Capacity]	W/W	1.9	2.1	2.3	2.0	2.0	
Indoor Unit	External Static Pressure-Rated	in.WG[Pa]	0	0	0	0	0
	External Static Pressure-Range	in.WG[Pa]	0	0	0	0	0
	Fan Motor Output	W	25	35	35	52	52
	Indoor Air Flow [Hi2/Hi/ Med/ Lo]	CFM	350/290/255/220	470/435/390/350	580/545/475/410	885/790/735/680	980/910/845/770
		m³/h	588/495/433/374	798/738/663/589	988/922/804/693	1503/1345/1247/1154	1662/1544/1435/1309
	Sound Pressure Level [Hi2/Hi/ Med/ Lo]	dB[A]	42/37/34/30	40/37/34/31	48/45/42/38	44/42/40/38	47/45/43/41
	Dimension [W×H×D]	inch	[36-49/64]×[10-5/8]×[8-17/64]	[47-3/4]×[12-13/32]×[9-3/8]	[47-3/4]×[12-13/32]×[9-3/8]	[54-21/64]×[14-7/8]×[11-39/64]	[54-21/64]×[14-7/8]×[11-39/64]
		mm	934×270×210	1213×315×238	1213×315×238	1380×378×295	1380×378×295
	Net Weight	lbs[kg]	19.8[9.0]	30.9[14.0]	30.9[14.0]	54.0[24.5]	54.0[24.5]
	Drainage water pipe diameter	inch[mm]	1-1/4[Φ32]	1-1/4[Φ32]	1-1/4[Φ32]	1-1/4[Φ32]	1-1/4[Φ32]
Sound Pressure Level	dB[A]	55	55	55	55	55	
Outdoor Unit	Throttle Type	Electronic Expansion Value		Electronic Expansion Value		Electronic Expansion Value	
	Dimension [W×H×D]	inch	[31-57/64]×[23-1/32]×[11-1/32]	[31-57/64]×[23-1/32]×[11-1/32]	[35-7/16]×[26-3/16]×[12-19/32]	[35-7/16]×[26-3/16]×[12-19/32]	[37-13/32]×[38-31/32]×[12-19/32]
		mm	810×585×280	810×585×280	900×665×320	900×665×320	950×990×320
	Net Weight	lbs[kg]	77.2[35.0]	77.2[35.0]	97.0[44.0]	101.4[46.0]	194.0[88.0]
Refrigerant type / Quantity	Type	R32		R32		R32	
	Charge	lbs[kg]	1.98[0.9]	1.98[0.9]	2.65[1.2]	3.09[1.4]	5.73[2.6]
Design pressure	H/L	PSIG	602/321	602/321	602/321	602/321	602/321
		MPa	4.15/2.21	4.15/2.21	4.15/2.21	4.15/2.21	4.15/2.21
Refrigerant Piping	Liquid side	inch[mm]	[1/4] Φ6.35	[1/4] Φ6.35	[1/4] Φ6.35	1/4[Φ6.35]	[3/8] Φ9.52
	Gas side	inch[mm]	[1/2] Φ12.7	[1/2] Φ12.7	[1/2] Φ12.7	1/2[Φ12.7]	[5/8] Φ15.88
	Max. pipe length	ft[m]	164[50]	164[50]	164[50]	164[50]	246[75]
	Max. Height difference	ft[m]	98.4[30]	98.4[30]	98.4[30]	98.4[30]	98.4[30]
	Add Refrigerant Amount	oz/ftg[m]	0.194[18]	0.194[18]	0.194[18]	0.194[18]	0.376[35]
	Chargeless	ft[m]	98.4[30]	98.4[30]	98.4[30]	98.4[30]	98.4[30]
Guaranteed Temperature Operation Range	Cooling	°F[°C]	0-115[-18~46]	0-115[-18~46]	0-115[-18~46]	0-115[-18~46]	0-115[-18~46]
	Heating	°F[°C]	-13-75[-25~24]	-13-75[-25~24]	-13-75[-25~24]	-13-75[-25~24]	-13-75[-25~24]