

# INSTALLATION MANUAL

## airHome 600

SPLIT UNIT AIR CONDITIONER

INDOOR UNIT  
RAK-GJ12PHAA



OUTDOOR UNIT  
RAC-GJ12WHAA

EN INSTRUCTION MANUAL

### FOR SERVICE PERSONNEL ONLY

- Carefully read through the procedures of proper installation before starting installation work.
- The sales agent should inform customers regarding the correct operation of installation.

#### Tools Needed For Installation Work

- ⊙ mark is tool exclusive use for R32
- ⊕ Screwdriver
- Measuring Tape
- Knife
- Saw
- Pipe Cutter
- Hexagonal Wrench Key ( 1/2" 5/32"(4mm))
- Power Drill (ø 2-18/32" (65mm) ~ ø 3-5/32" (80mm))
- Vacuum Pump
- Pliers or Wrench
- Torque Wrench
- Vacuum Pump Adaptor
- Flare Tool
- Gas Leakage Detector
- Manifold Valve
- Charge Hose
- Reamer
- File

### SAFETY PRECAUTION

- Read the safety precautions carefully before operating the unit.
- This appliance is filled with R32.
- The contents of this section are vital to ensure safety. Please pay special attention to the following sign.
- WARNING** ..... Incorrect methods of installation may cause death or serious injury.
- CAUTION** ..... Improper installation may result in serious consequence.
- Make sure to connect earth line.**
- This sign in the figures indicates prohibition.**

Be sure that the unit operates in proper condition after installation. Explain to customer the proper operation and maintenance of the unit as described in the user's guide. Ask a customer to keep this installation manual together with the instruction manual.

Cooling & Heating

<IA2691: A>

## HITACHI

### WARNING

- Flare nut must use a torque wrench without fail. Tighten with the specified tightening torque. If the flare nut is tightened too much, after a long period of time, the flare nut breaks. Gas leakage, stagnation, touching fire, rarely cause ignition.
- Sharp bending of the pipe use the polyethylene rod, bend not crushed the pipe. Gas leakage from the crushed part, stagnation, touching fire, rarely cause ignition.
- Please request your sales agent or qualified technician to install your unit. Water leakage, short circuit or fire may occur if you do the installation work yourself.
- Please observe the instructions stated in the installation manual during the process of installation. Improper installation may cause water leakage, electric shock and fire.
- Make sure that the units are mounted at locations which are able to provide full support to the weight of the units. If not, the units may collapse and impose danger.
- Observe the rules and regulations of the electrical installation and the methods described in the installation manual when dealing with the electrical work. Use cables which are officially approved in your country. Be sure to use the specified circuit. A short circuit and fire may occur due to the use of low quality wire or improper work.
- Be sure to use the specified cables for connecting the indoor and outdoor units. Please ensure that the connections are tight after the conductors of the wire are inserted into the terminals to prevent the external force is being applied to the connection section of the terminal base. Improper insertion and loose contact may cause over-heating and fire.
- Unauthorized modifications to the installation work. Otherwise, the units may collapse or water leakage, electric shock, fire or stronger vibration may occur.
- Be sure to use the specified piping set for R32. Otherwise, this may result in broken copper pipes or faults.
- When installing or transferring an air conditioner to another location, make sure that air other than the specified refrigerant(R32) does not enter the refrigeration cycle. If other air should enter, the pressure level of the refrigeration cycle may increase abnormally which could result in a rupture and injury.
- Be sure to ventilate fully if a refrigerant gas leak while at work. If the refrigerant gas comes into contact with fire, a poisonous gas may occur.
- After completion of installation work, check to make sure that there is no refrigeration gas leakage. If the refrigerant gas leaks into the room, coming into contact with fire in the fan-driven heater, space heater, etc., a poisonous gas may occur.
- Unauthorized modifications to the air conditioner may be dangerous. If a breakdown occurs please call a qualified air conditioner technician or electrician. Improper repairs may result in water leakage, electric shock and fire, etc.
- Be sure to connect the earth line from the power supply wire to the outdoor unit and between the outdoor and indoor unit. Do not connect the earth line to the gas tube, water pipe, lighting rod or the earth line of the telephone unit. Improper earthing may cause electric shocks.
- When finishing the refrigerant collection (pumping down), stop the compressor and then remove the coolant pipe. If you remove the refrigerant pipe while the compressor is operating and the service valve is released, air is sucked and a pressure in the freezing cycle system will build up steeply, causing an explosion or injury.
- When installing the unit, be sure to install the refrigerant pipe before starting the compressor. If the refrigerant pipe is not installed and the compressor is operated with the service valve released, air is sucked and the pressure level of the refrigeration cycle may increase abnormally which could result in a rupture and injury.
- The electric cables should neither be reworked nor added. Make sure to use an exclusive circuit breaker. Otherwise fire or electric shock might occur by connection failure, isolation failure or over current.
- Make sure to connect cables to terminal properly and terminal cover should close firmly. Otherwise, over heating at terminal contact, fire or electric shock might occur.
- Make sure that there is no dust on any connected points of electric cables and fix firmly. Otherwise, fire or electric shock might occur.
- This appliance is not intended for use by persons (including children) with reduced physical, sensory or mental capabilities or lack of experience and knowledge, unless they have been given supervision or instruction concerning use of the appliance by a person responsible for their safety. Children should be supervised to ensure that they do not play with the appliance.
- Appliance shall be installed in accordance with national wiring regulations and is not intended for use at altitudes exceeding 2000m (6561-22/32ft).

### THE CHOICE OF MOUNTING SITE (Please note the following matters and obtain permission from customer before installation).

#### INDOOR UNIT

### WARNING

- The unit should be mounted at stable, non-vibratory location which can provide full support to the unit.

### CAUTION

- No nearby heat source and no obstruction near the air outlet is allowed.
- The clearance distances from top, right and left are specified in figure below.
- The location must be convenient for water drainage and pipe connection with the Outdoor Unit.
- To avoid interference from noise please place the unit and its remote controller at least 3-9/32ft (1m) from the radio, television and inverter type fluorescent lamp.
- To avoid any error in signal transmission from the remote controller, please put the controller far away from high-frequency machines and high-power wireless systems.
- The installation height of indoor unit must be 7-35/64ft (2.3m) or more.

### OUTDOOR UNIT

### WARNING

- The outdoor unit must be mounted at a location which can support heavy weight. Otherwise, noise and vibration will increase.

### CAUTION

- A circuit breaker or fuse must be installed. Without a circuit breaker or fuse the danger of electric shock exists. The external switch shall be incorporated to completely disconnect from power supply. It should disconnect all poles, and a contact separation of at least 4/32" (3mm) must be present.
- Do not install the unit near a location where there is flammable gas. The outdoor unit may catch fire if flammable gas leaks around it.
- Do not install the indoor unit in a machine shop, kitchen and laundry rooms when vapor from oil or its mist flows to the indoor unit. The oil will deposit on the heat exchanger, thereby reducing the indoor unit performance and may deform and in the worst case, break the plastic parts of the indoor unit.
- Please ensure smooth flow of water when installing the drain hose.
- Piping shall be suitable supported with a maximum spacing of 3-9/32ft (1m) between the supports.
- Selecting the installation location: Suitable location that will reduce the impact from rain and direct sun that may affect the unit performance. Besides that, ventilation must be good and clear of obstruction.
- The air blown out of the unit should not point directly to animals or plants.
- The clearances of the unit from top, left, right and front are specified in figure below. At least three of the above sides must be open air.
- Be sure that the hot air blown out of the unit and noise do not disturb the neighbourhood.
- Do not install at a location where there is flammable gas, steam, oil and smoke.
- The location must be convenient for water drainage.
- Place the outdoor unit and its connecting wire at least 3-9/32ft (1m) away from the antenna or signal line of television, radio or telephone. This is to avoid noise interference.
- Do not install outdoor unit facing strong wind direction. It may damage the fan motor.
- Do not install the outdoor unit in a place where small animals may build their nests. If small animal goes inside the unit and touches the electrical parts, failure of the unit, smoke or fire may be caused. Request your customer to keep the surrounding of the unit is clean.
- Safely dispose all packing and transportation materials in accordance with federal/state/local laws ordinances. Packing materials such as nails and other metal or wood parts, including plastic packing materials used for transportation may cause injuries or death by suffocation.
- The maximum number of pieces of equipment permitted to be stored together will be determined by local regulations. Storage package protection should be constructed in such a way that mechanical damage to the equipment inside the package will not cause a leak of the REFRIGERANT CHARGE.

#### Names of Indoor Components

No.	Component's Name	Qty
①	Mounting Plate	1
②	Screw for Mounting Plate (5/32 x 1-17/64) (4.1 x 32)	6
③	Holder for Remote Controller	1
④	AAA Size Battery	2
⑤	Screw for holder of Remote Controller (1/8 x 5/8) (3.1 x 16)	2
⑥	Remote Controller	1
⑦	Purifying Filter	2
⑧	Wi-Fi Adapter	1

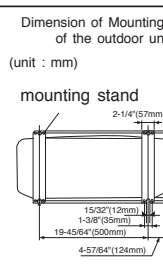
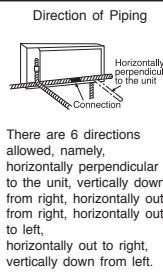

#### Figure showing the Installation of Indoor and Outdoor Unit.

### CAUTION

In case the pipe length is more than the recommended length for chargeless, add refrigerant R32 as below. Do not exceed the maximum pipe length.

### CAUTION

- This unit is chargeless up 49-7/32ft (15m) pipe length.
- Installation of pipe length less than minimum pipe length requirement 9-27/32ft (3m) may generate an abnormal sound.

Model	Max. Pipe ft(m)	Chargeless up to ft(m)	Additional R32 oz(ft/gm)	The maximum refrigerant charge (mmax)
RAC-GJ12WHAA	82-1/32ft (25m)	49-7/32ft (15m)	0.11oz/ft (10g/m)	44.45oz (1260g)

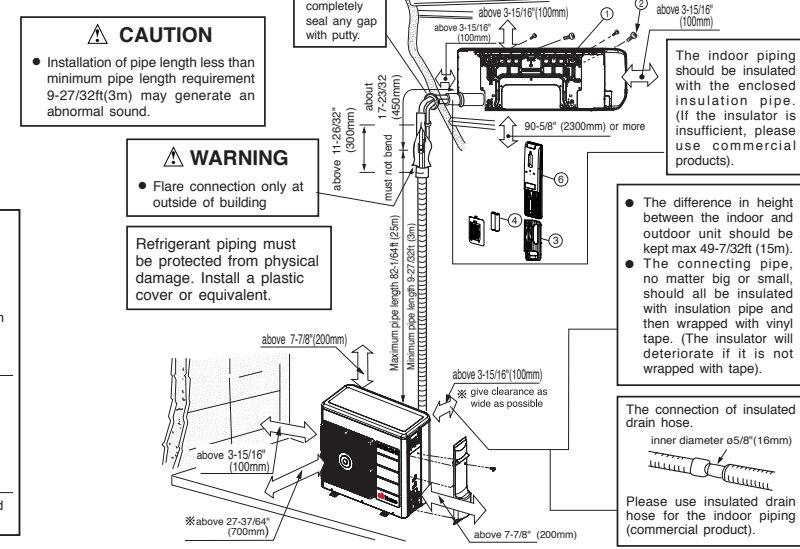

### 1 Installation of Hanger, Wall Penetration and Installation of Protection Pipe

### CAUTION

- The draining of the water container inside the indoor unit can be done from the left. Therefore the mounting plate must be fixed horizontally or slightly tilted towards the side of drain hose. Otherwise, condensed water may overflow the water container.

#### Direct Mounting On The Wall

- Please use hidden beams in the wall to hold the mounting plate.

Screw the hanger at the positions possibly near the upper and lower hooks where the indoor unit is hung. Use 4 or more screws to fix the hanger.

#### Procedures of Installation and Precautions

Procedures to fix the mounting plate.

- Drill holes on wall. (As shown below)
- Push plug into the holes. (As shown below)
- Fix the mounting plate on wall with 5/32 x 1-17/64 (4.1 x 32) screw (As shown in figure below)

Procedures to fix the holder of remote control.

- Drill holes on wall. (As shown below)
- Push plug into the holes. (As shown below)

#### Wall Penetration and Installation of Protection Pipe

- Drill a ø 2-9/16" (65mm) hole on wall which is slightly tilted towards the outdoor side. Drill the wall at a small angle.
- Cut the protection pipe according to the wall thickness.
- Empty gap in the sleeve of protection pipe should be completely sealed with putty to avoid dripping of rain water into the room.

### 2 Installation of the Indoor Unit

#### VERTICALLY DOWNWARD PIPING

#### Preparation

- Connect connecting cord.
- Pull out the pipe, connecting cord and drain hose.

#### Installation

- The upper part of the indoor unit is hanged on the mounting plate.
- The projection at the lower part of the indoor unit is hooked onto the mounting plate.

#### HORIZONTAL PIPING

#### Preparation

Change of Drain Hose and Installation Procedures.

- Exchange the location of drain hose and drain cap during horizontal piping as shown in figure below. Be sure to plug in the drain hose until the insulating material folds upon itself.

#### CAUTION

For horizontally out to right piping

For right piping, follow the instruction as below:

- Press the upper side of clamp
- Unfold the pipe to downward slowly.
- Bend the pipe to the right side of chassis.

Remove the cap for drain hose installation

### INSTALLATION OF REFRIGERATING PIPES AFTER CONNECTION

- The refrigerating pipes should be adjusted to fit into the hole on the wall and then ready for further connection.
- The terminals of 2 connected pipes must be covered with insulator used for terminal connection. Then the pipes are wrapped with insulation pipe.
- Connect the connecting cord after removing electrical cover. (Refer to "CONNECTION OF POWER CORD")
- After adjustment, fit the connecting cord and pipes into the space available under the indoor unit.
- When connection is at left side, refrigerating pipe and cabinet shall be tied together. Failing to do so may cause the unit bottom side become warping. Excess binder shall be cut to prevent abnormal sound and water dripping.

#### THE CONNECTION OF REFRIGERATING PIPE DURING THE INSTALLATION OF INDOOR UNIT

#### Preparation To Install Refrigerating Pipes

- The end of the refrigerating pipes are at locations marked with "▽" symbol.

#### Installation

Hang the indoor unit onto the mounting plate. Use the temporary stand at the back of the indoor unit to push its lower part 5-29/32" (150mm) forwards.

- Place the drain hose through the hole on the wall.
- Wrap the refrigerating pipes with insulation pipe after connecting refrigerating pipe.
- Connect the connecting cord after removing electrical cover. (Refer to "Connection of Power Cord")
- After adjustment, the connecting cord and refrigerating pipes are placed into the space available under the indoor unit.
- The projection of indoor unit must hook to the mounting plate.

### 3 Installation of Drain Hose

### CAUTION

- Do not guide the drain hose to places where corrosive gases (sulfur, ammonia, etc.) are generated, such as septic tanks and sewer. Corrosive gas may flow backward from the drain hose to the indoor unit, corrode the copper pipe, or it may cause offensive odors in the room.
- Cut the drain hose at a position 3-15/16" (100mm) higher than the floor surface. It may cause water leakage due to air lock or clogging of foreign matter.

<IA2691: A>

- Please mount the outdoor unit on stable ground to prevent vibration and increase of noise level.
- Decide the location for piping after sorting out the different types of pipe available.
- Open the side plate by unscrewing the screws as shown below.

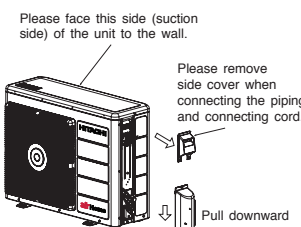

- CONDENSED WATER DISPOSAL OF OUTDOOR UNIT**
- There are holes on the base of Outdoor unit for condensed water to exhaust.
  - In order to flow condensed water to the drain, the unit is installed on a stand or a block so that the unit is 3-15/16" (100mm) above the ground as shown figure. Join the drain pipe to one hole.
  - At first insert one portion of the hook to the base (Portion A), then pull the drain pipe in the direction shown by the arrow while inserting the hook into the base. After installation, check whether the drain pipe cling to the base firmly.

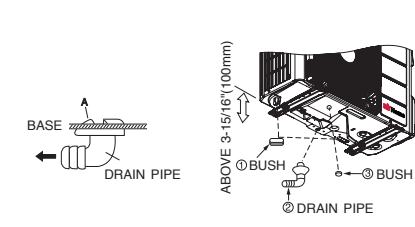

**When Using and Installing In Cold Areas**  
When the air conditioner is used in low temperature and in snowy conditions, water from the heat exchanger may freeze on the base surface to cause poor drainage. When using the air conditioner in such areas, do not install the bushings. Keep a minimum of 9-27/32" (250mm) between the drain hole and the ground. When using the drain pipe, consult your sales agent.  
✖ For more details, refer to the installation Manual for Cold Areas.

- Use the two spanners on the service valve nuts to tighten and loosen so that the service valve will not deform. Gas leak from the crushed part, stagnation, touching fire, rarely cause ignition.



**WARNING**

- BURST HAZARD**  
Do not allow air, etc. to get into refrigerant cycle (piping)
- RISK OF EXPLOSION**  
Compressor must be stopped before removing refrigerant pipes.  
All service valve must be fully closed after pumping down operation.

**PURGING OF REFRIGERANT IS PROHIBITED**  
Purging of refrigerant will cause the unit to be lacked of refrigerant which may affect the capacity performance and lead to severe dew formation causing problem such as dew water drop or splashing from the unit.

When connecting pipes. If you tighten the flare nut by excess torque, the service valve on the small pipe side may be broken.  
The flare nut on the small pipe side should be torqued to 122 - 165lbf.in (140 - 190kgf.cm).

**1 Preparation of Pipe**

- Use a pipe cutter to cut the copper pipe.
- CAUTION**
- Jagged edge will cause leakage.
  - Point the side to be trimmed downwards during trimming to prevent copper chips from entering the pipe.
  - Before flaring, please put on the flare nut.

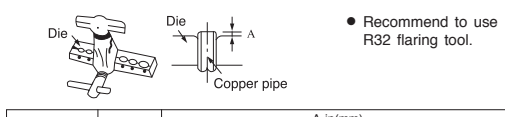

Outer diameter in(mm)	Thickness in(mm)	A in(mm)		
		Flare tool for R32 Clutch type	Conventional flare tool Clutch type Wing nut type	
1/4"(6.35mm)	1/32(0.8)	0-1/64(0.0-0.5)	3/64-1/16(1.0-1.5)	1/16-5/64(1.5-2.0)
3/8"(9.52mm)	1/32(0.8)	0-1/64(0.0-0.5)	3/64-1/16(1.0-1.5)	1/16-5/64(1.5-2.0)
1/2"(12.70mm)	1/32(0.8)	0-1/64(0.0-0.5)	3/64-1/16(1.0-1.5)	1/16-3/32(1.5-2.5)
5/8"(15.88mm)	3/64(1.0)	0-1/64(0.0-0.5)	3/64-1/16(1.0-1.5)	1/16-3/32(1.5-2.5)

**2 Pipe Connection**

- CAUTION**
- When removing flare nut from the Indoor unit, please ensure to use proper tooling.
  - Prevent pipe from coming in contact with water or working in wet area.

	Outer dia. of pipe in(mm)	Torque N.m (lbf.ft)
Small dia. side	1/4" (6.35)	13.7-18.6 N.m (10.08-13.66 lbf.ft)
	3/8" (9.52)	34.3-44.1 N.m (25.20-32.40 lbf.ft)
	1/2" (12.7)	44.1-53.9 N.m (32.40-39.60 lbf.ft)
Large dia. side	5/8" (15.88)	49.0-58.8 N.m (36.00-43.20 lbf.ft)
	1/4" (6.35)	19.6-24.5 N.m (14.40-18.00 lbf.ft)
	3/8" (9.52)	19.6-24.5 N.m (14.40-18.00 lbf.ft)
Valve head cap	1/2" (12.7)	29.4-34.3 N.m (21.60-25.20 lbf.ft)
	5/8" (15.88)	29.0-31.0 N.m (21.31-22.75 lbf.ft)
	Valve core cap	12.3-15.7 N.m (8.75-11.52 lbf.ft)

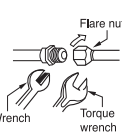

**3 Removal Of Air From The Pipe And Gas Leakage Inspection**

**Procedures of using Vacuum Pump for Air Removal**

- As shown in right figure, remove the cap of valve core. Then, connect the charge hose. Remove the cap of valve head. Connect the vacuum pump adapter to the vacuum pump and connect the charge hose to the adapter.
- Fully tighten the "Hi" knob of the manifold valve and completely unscrew the "Lo" knob. Run the vacuum pump for about 10-15 minutes, then completely tighten the "Lo" knob and switch off the vacuum pump. After vacuuming, confirm that the needle of the manifold gauge is stable for 3-5 minutes.
- Remove the charge hose and tighten the cap of valve core. Check the cap's periphery if there is any gas leakage.
- Completely unscrew the spindle of the service valve (at 2 places) in anti-clockwise direction to allow the flow of refrigerant (using Hexagonal Wrench key).
- Re-cap the service valve and tighten using wrench. Check the cap's periphery if there is any gas leakage. The task is then completed.

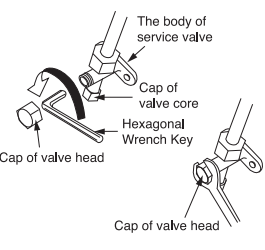
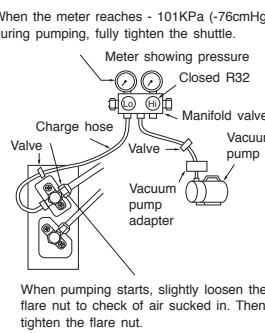

**Gas Leakage Inspection**

Please use gas leakage detector to check if leakage occurs at the connection of Flare nut as shown on the right.  
If gas leakage occurs, further tighten the connection to stop leakage. (Use the detector provided for R32)

**CAUTION**

- Prevent moisture from entering pipe connection.
- Refrigerating machine oil is not applied to the outside of the flare.
- When refrigerating oil is applied to the outside of the flare and gas leakage may occur due to the excessive tightening of the flare nut.
- When using the control valve, do not use deteriorated packing. And, do not over-tighten the steering wheel. Gas leakage from the service valve part, stagnation, touching fire, rarely cause ignition.

**WARNING THIS APPLIANCE MUST BE EARTHED.**

**Procedures of Wiring**

In case that power is supplied from Indoor Unit

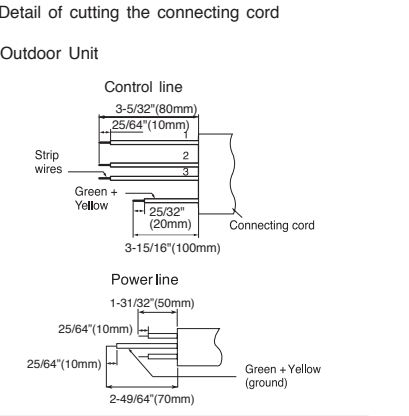
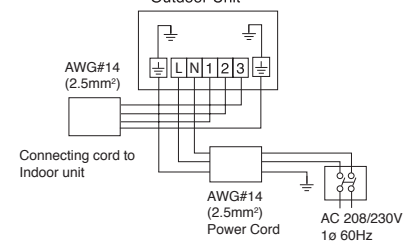

When removing the connecting wires for the indoor unit, please remove the low cover panel in front of the unit.

**WARNING**

- Leave some space in the connecting cord for maintenance purpose and be sure to secure it with the cord band.
- Secure the connecting cord along the coated part of the wire using the cord band. Do not exert pressure on the wire as this may cause overheating or fire.
- Supply cords, current-carrying conductors become taut before earthing conductor, if the cord slips out of the cord band.

**Checking for the electric source and the voltage range**

- Before installation, the power source must be checked and necessary wiring work must be completed. To make the wiring capacity proper, use the wire gauge list below for the wiring from house distribution fuse box to the outdoor unit in consideration of the locked rotor current.
- Investigate the power supply capacity and other electrical conditions at the installation location. Depending on the model of room air conditioner to be installed, request the customer to make arrangements for the necessary electrical work etc. The electrical work includes the wiring work up the outdoor. In localities where electrical conditions are poor, use of a voltage regulation is recommended.

**Wiring of The Indoor Unit**

- For wire connection of the Indoor unit, you need to remove the front cover, the low cover under the body of the unit and terminal cover.
- Remove the cover from the terminal base and screw the cable.

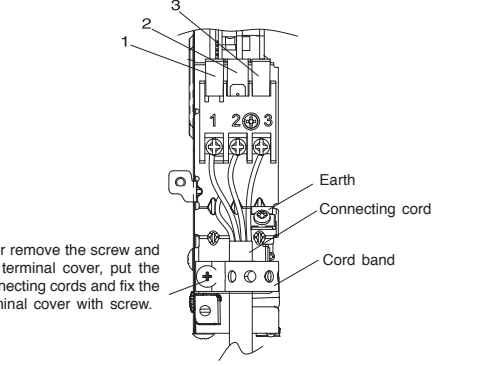

**Method to remove the low cover**

- Pull at the 1 and 2 in the directions as shown by arrows to remove the cover.

**How to connect the optional parts (H-LINK RAC Adapter, Dry contact, Wired Remote Controller)**

- For cable connection to control P.W.B., you need to remove front cover and electrical box cover. Each connecting location is as below.
- ① Dry contact: CN6
- ② H-LINK RAC Adapter: CN7B
- ③ Wired Remote Controller: CN20
- Please check and confirm manuals attached to each optional parts for more connection details.
- Please check service manual about how to set from remote controller.
- You can refer to this installation manual how to remove and re-attach the front cover.
- Please be careful not to damage lead wires by edge of plate when connecting the optional parts.
- Please do the operation test after the connection.

Wire cross-section	Wire length	Wire cross-section
AWG#14 (2.5 mm <sup>2</sup> )	up to 82-1/64ft(25m)	AWG#14 (2.5mm <sup>2</sup> )

**CAUTION**  
Note:  
• The supply cord of appliances for outdoor use shall be between 4-59/64ft & 9-27/32ft (1.5m & 3m) long and shall be either an EXTRA HARD USAGE or a HARD USAGE CORD.

**Wiring Of The Outdoor Unit**

- Please remove the side plate for wire connection.

- WARNING**
- If you cannot close the side cover due to the connecting cord, please tidy up the wiring for spacing at front panel.
  - Be sure that the hooks of the side cover is properly fixed to avoid water penetration. Otherwise water leakage may occur and this causes short circuit or faults.
  - The connection cord should not touch to service valve and pipe to avoid possibilities of burn. (It become high temperature in heating operation.)

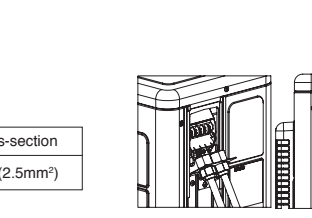

**IMPORTANT**

Maximum Overcurrent Protection Fuse
15A

**HOW TO REMOVE OR ATTACH THE FRONT COVER**

**How to Remove the Front Cover**

- Remove the front panel
- 
- Push the end of the right-side arm outward to release the tab.
  - Move the left-side arm outward to release the left tab, and then pull the panel towards you.
  - Remove the filters.
  - After removing 3 screws, remove the cover of electric box, pull the center of the front cover towards you and release the claws.
  - Pull the side faces (lower sections) of the front cover towards you as shown in the figure and remove the cover.

**How to Attach the Front Cover**

- After installing the front cover onto the unit, hook three claws at upper side of the cover securely. Then, push the center of the front cover to lock the claws.
  - Assemble the cover of electric box.
  - Tighten the 3 screws.
  - Install the filter.
  - Attaching the Front Panel
    - Insert the shaft of the left arm along the step on the unit into the hole.
    - Securely insert the shaft of the right arm along the step on the unit into the hole.
    - Make sure that the front panel is securely attached, and then close the front panel.
- 

**HOW TO REMOVE INDOOR UNIT**

- Push up the (PUSH) sections at the bottom of the indoor unit and pull the bottom plate towards you. Then the claws are released from the stationary plate. (The (PUSH) sections are indicated by 2 arrows as below figure)
- 

**1 Insulation And Maintenance Of Pipe Connection**

- The connected terminals should be completely sealed with heat insulator and then tied up with rubber strap.
- Please tie the pipe and power line together with vinyl tape as shown in the figure showing the installation of Indoor and Outdoor units. Then fix their position with holders.
- To enhance the heat insulation and to prevent water condensation, please cover the outdoor part of the drain hose and pipe with insulation pipe.
- Completely seal any gap with putty.

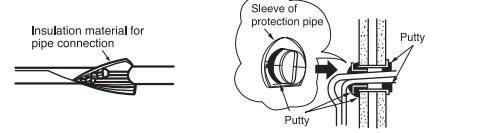

**3 Power Source And Operation Test**

- Power Source**
- CAUTION**
- Please use a new socket. Accident may occur due to the use of old socket because of poor contact.
  - Please plug in and then remove the plug for 2 - 3 times. This is to ensure that the plug is completely plugged into the socket.
  - Keep additional length for the power cord and do not render the plug under external force as this may cause poor contact.
  - Do not fix the power cord with U-shape nail.

**Operation Test**

- Please be sure to measure the supply voltage before operation test.
- Please ensure that the air conditioner is in normal operating condition during the operation test.
  - Operate with Cool Mode(in summer) or Heat Mode(in winter).
  - Press Temperature Button on the remote controller to set the desired temperature to 60°F (16.0°C) for Cool Mode or 90°F (32.0°C) for Heating Mode. Set the desired fan speed to "High".
  - Operate the air conditioner for 20 minutes at least and make sure that the air from the air conditioner is cool or warm.
  - Press the ON/OFF button on the remote controller to make sure that the air conditioner stops running.
- If the indication lamps of the indoor unit blink with sounding the buzzer during the operation test, perform a check following the procedures below.

Indication lamps blinking mode	What to check
All indication lamps blink three times repeatedly.	Make sure that the spindles of both service valves are open. (Outdoor fan might operate for near 15 minutes after the operation stop for the protection. For the reoperation at that case, do it after outdoor fan will stop.)

- Before the check and the reoperation, reset the power supply by turning off and on the circuit breaker only after
  - waiting for at least 5 minutes; or
  - pressing the Temporary Switch Button only once while the power is OFF.

**CAUTION**

- Don't operate for over 5 minutes with the situation that the spindle of the service valve is closed. This will cause the defect.
- Don't operate by Cool Mode or Dry Mode with the door and windows opened, (the room humidity is always above 80%) for a long period of time. Water will condense and drip down occasionally. This will wet your furniture.
- Explain to your customer the proper operation procedures as described in the user's manual.
- If the indoor unit won't operate, check the cable for correct connection.
- Turn on the lamp in the room where the indoor unit is installed and check the remote controller for normal operation.

**2 Installation Of Remote Controller**

- The remote controller can be placed in its holder which is fixed on wall or beam.
- To operate the remote controller at its holder, please ensure that the unit can receive signal transmitted from the controller at the place where the holder is to be fixed. The unit will beep when signal is received from the remote controller. The signal transmission is weaker by the fluorescent light. Therefore, during the installation of the remote control holder, please switch on the light, even during day time, to determine the mounting location of the holder.

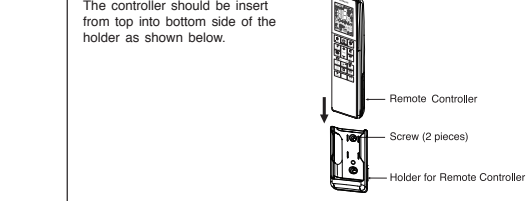

**Explanation of symbols displayed on unit**

Symbol	Explanation
Flame symbol	Refrigerant Safety Group A2L
Warning symbol	WARNING: This appliance is filled with R32
Book symbol	CAUTION: This symbol shows that the Operation Instructions should be read carefully.
Book symbol	CAUTION: This symbol shows that a service personnel should be handling this equipment with reference to the Installation Manual.
Information symbol	CAUTION: This symbol shows that there is information included in the Operation Manual and/or Installation Manual.

**California Proposition 65**

**WARNING**  
Proposition 65: This product contains chemicals known to the state of California to cause cancer, birth defects, and other reproductive harm. For more information, go to [www.P65Warnings.ca.gov](http://www.P65Warnings.ca.gov)